

**HORIZON**<sup>®</sup>  
H O B B Y

**E-flite**<sup>®</sup>  
ADVANCING ELECTRIC FLIGHT

# Opterra<sup>®</sup> 1.2m

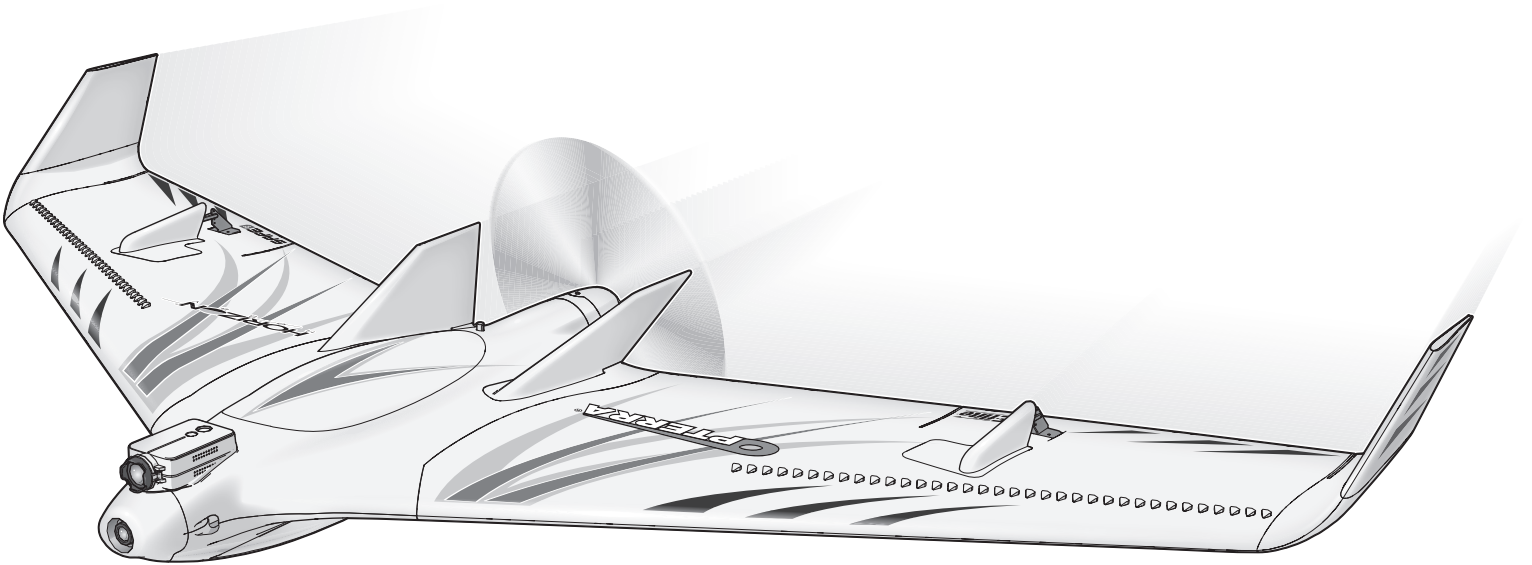

*Instruction Manual*  
*Bedienungsanleitung*  
*Manuel d'utilisation*  
*Manuale di Istruzioni*

**SAFE**<sup>®</sup> 

SAFE<sup>®</sup> Select Technology, Optional Flight Envelope Protection

Bind-N-Fly<sup>®</sup> Plug-N-Play<sup>®</sup>  
BASIC

**NOTICE**

All instructions, warranties and other collateral documents are subject to change at the sole discretion of Horizon Hobby, LLC. For up-to-date product literature, visit [www.horizonhobby.com](http://www.horizonhobby.com) and click on the support tab for this product.

**Meaning of Special Language:**

The following terms are used throughout the product literature to indicate various levels of potential harm when operating this product:

**WARNING:** Procedures, which if not properly followed, create the probability of property damage, collateral damage, and serious injury OR create a high probability of superficial injury.

**CAUTION:** Procedures, which if not properly followed, create the probability of physical property damage AND a possibility of serious injury.

**NOTICE:** Procedures, which if not properly followed, create a possibility of physical property damage AND little or no possibility of injury.



**WARNING:** Read the ENTIRE instruction manual to become familiar with the features of the product before operating. Failure to operate the product correctly can result in damage to the product, personal property and cause serious injury.

This is a sophisticated hobby product. It must be operated with caution and common sense and requires some basic mechanical ability. Failure to operate this Product in a safe and responsible manner could result in injury or damage to the product or other property. This product is not intended for use by children without direct adult supervision. Do not use with incompatible components or alter this product in any way outside of the instructions provided by Horizon Hobby, LLC. This manual contains instructions for safety, operation and maintenance. It is essential to read and follow all the instructions and warnings in the manual, prior to assembly, setup or use, in order to operate correctly and avoid damage or serious injury.

**14+**

**AGE RECOMMENDATION:**  
Not for children under 14 years. This is not a toy.



**WARNING AGAINST COUNTERFEIT PRODUCTS:** If you ever need to replace your Spektrum receiver found in a Horizon Hobby product, always purchase from Horizon Hobby, LLC or a Horizon Hobby authorized dealer to ensure authentic high-quality Spektrum product. Horizon Hobby, LLC disclaims all support and warranty with regards, but not limited to, compatibility and performance of counterfeit products or products claiming compatibility with DSM or Spektrum technology.

## Safety Precautions and Warnings











As the user of this product, you are solely responsible for operating in a manner that does not endanger yourself and others or result in damage to the product or the property of others.

- Always keep a safe distance in all directions around your model to avoid collisions or injury. This model is controlled by a radio signal subject to interference from many sources outside your control. Interference can cause momentary loss of control.
- Always operate your model in open spaces away from full-size vehicles, traffic and people.
- Always carefully follow the directions and warnings for this and any optional support equipment (chargers, rechargeable battery packs, etc.).
- Always keep all chemicals, small parts and anything electrical out of the reach of children.
- Always avoid water exposure to all equipment not specifically designed and protected for this purpose. Moisture causes damage to electronics.
- Never place any portion of the model in your mouth as it could cause serious injury or even death.
- Never operate your model with low transmitter batteries.
- Always keep aircraft in sight and under control.

- Always use fully charged batteries.
- Always keep transmitter powered on while aircraft is powered.
- Always remove batteries before disassembly.
- Always keep moving parts clean.
- Always keep parts dry.
- Always let parts cool after use before touching.
- Always remove batteries after use.
- Always ensure failsafe is properly set before flying.
- Never operate aircraft with damaged wiring.
- Never touch moving parts.

If you are operating the BNF with FPV version of this product (EFL11460) in North America, you are required to have an Amateur Radio (HAM) license. Visit [www.arrl.org](http://www.arrl.org) for more information.

# Box Contents

		<b>BNF</b> BASIC with FPV EFL11460*	<b>BNF</b> BASIC EFL11450	PNP PLUG-N-PLAY EFL11475
	<b>Motor:</b> 480 Brushless outrunner, 960Kv (EFL11407)	Installed	Installed	Installed
	<b>ESC:</b> 18A (EFLA1030BC)	Installed	Installed	Installed
	<b>Servos:</b> 2 Aileron Servos, (EFLR7155)	Installed	Installed	Installed
	<b>Receiver:</b> SPM4647 <b>Flight Controller:</b> SPMA3235	Installed	Installed	Not Included
	<b>GPS module:</b> SPMA3173	Installed	Not included	Not Included
	<b>FPV Camera:</b> SPMVC602	Installed	Not included	Not included
	<b>Video transmitter:</b> SPMVT1001	Installed	Not included	Not included
	<b>Battery:</b> 3S 2200mAh Li-Po (EFLB22003S20)	Required to Complete	Required to Complete	Required to Complete
	<b>Battery Charger:</b> Li-Po battery balancing charger	Required to Complete	Required to Complete	Required to Complete
	<b>Recommended Transmitter:</b> Full-Range 6 channel 2.4GHz with Spektrum DSMX® technology	Required to Complete	Required to Complete	Required to Complete

\*The Opterra 1.2m S+ BNF with FPV (EFL11460) is not available in Europe

The operating frequency of the aircraft is 2404-2476 MHz

SPMVT1001 Analog VTX is 5.8GHz (1mw-600mw adjustable) and requires an amateur radio license in North America (installed in EFL11460 BNF with FPV).

SPMVT1001EU is an Analog 5.8GHz device (1mw-25mw adjustable) and is certified for use without a license in Europe (available separately).

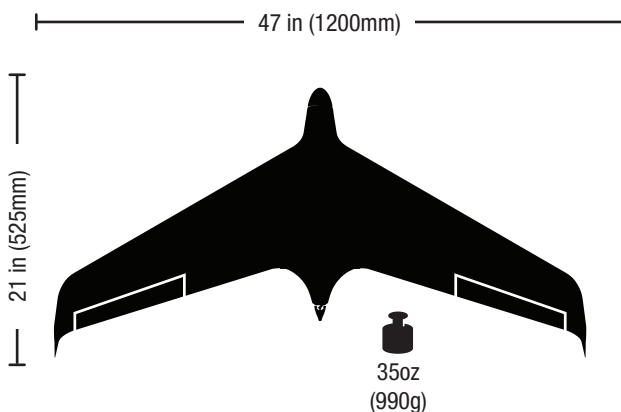

To receive product updates, special offers and more, register your product online at [www.e-fliterc.com](http://www.e-fliterc.com)

If you own this product, you may be required to register with the FAA. For up-to-date information on how to register with the FAA, visit <https://registermyuas.faa.gov/>. For additional assistance on regulations and guidance on UAS usage, visit [knowbeforeyoufly.org/](http://knowbeforeyoufly.org/).

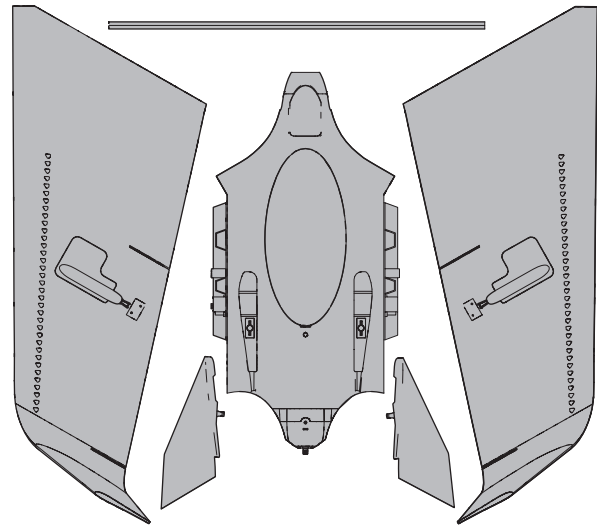

## Table of Contents

- SAFE® Plus Technology (BNF with FPV) ..... 4
- Transmitter Setup (BNF) ..... 4
- CRSF compatibility ..... 4
- Transmitter Setup (PNP) ..... 5
- Transmitter and Receiver Binding ..... 5
- Model Assembly ..... 6
- Battery Installation and ESC Arming ..... 7
- Compass Calibration Procedure (BNF with FPV) ..... 8
- Choose a Flying Field ..... 8
- Video System (BNF with FPV) ..... 9
- Using the Video Transmitter ..... 10
- Install the Propeller ..... 11
- Center of Gravity (CG) ..... 11
- AS3X/SAFE Control Direction Test ..... 11
- Flight Preparation ..... 12
- Trimming the Aircraft ..... 12
- Flying ..... 13
- Virtual Fence Flight Modes (BNF with FPV only) ..... 13
- Virtual Fence Mode (BNF with FPV) ..... 14
- GPS Initialization (BNF with FPV) ..... 15
- LED Display (BNF with FPV only) ..... 15
- Throttle Cut in GPS modes (BNF with FPV only) ..... 15
- Flight Patterns (BNF with FPV) ..... 16
- Landing ..... 17
- Deactivating GPS (BNF with FPV) ..... 18
- Service and Repairs ..... 19
- Upgrading PNP and BNF Basic ..... 19
- Trouble Shooting Guide ..... 20
- AMA National Model Aircraft Safety Code ..... 21
- Limited Warranty ..... 22
- Contact Information ..... 22
- FCC Information ..... 23
- IC Information ..... 23
- Compliance Information for the European Union ..... 23
- Recommended Receivers ..... 86
- Replacement Parts ..... 87
- Optional Parts ..... 88

## SAFE® Plus Technology (BNF with FPV)

There are three configurations for the Opterra 1.2m aircraft. A PNP option (EFL11475) requires pilots to install their selected control and FPV systems. A BNF Basic package (EFL11450) offers the proven SAFE® and AS3X® technologies and does not include any FPV equipment or GPS features. The BNF Basic with FPV package (EFL11460) includes SAFE Plus technology which adds GPS based features to airplanes for advanced drone-like capabilities. GPS also enables an On Screen Display (OSD) system to show helpful information for the flight on top of the video image.

In addition to making the airplane generally stable and easy to fly, SAFE Plus technology can keep the airplane within the flying area, let the pilot have time to think while the aircraft cruises in a holding pattern, and it can land the aircraft automatically. No complex programming is required for AutoLand, Holding Pattern, and Virtual Fence.

When flying in beginner mode, the airplane has sensors to prevent aggressive maneuvering. In that mode, limitations keep the pilot from over-controlling, and

automatic self-leveling makes recovery from risky or confusing attitudes as simple as releasing the sticks.

With Virtual Fence the airplane uses GPS technology to prevent the pilot from flying too far from home. If the airplane passes the Virtual Fence, the model will turn around to fly home by itself. Control is returned to the pilot when the airplane is within the Virtual Fence again.

Engage Holding Pattern or Loiter mode to enjoy a cruise around the flying area, the model will continue to circle the area in Holding Pattern or Loiter mode with no pilot commands. When it's time to land, AutoLand brings the airplane down and performs an automatic landing with no pilot assistance, right at the designated home location.

Safe Plus technology flight modes are selected at the flip of a switch and include an intermediate mode and advanced mode. Experienced pilots can fly without restraints in the AS3X flight mode. When flying in the AS3X flight mode, self leveling features are disabled.

## Transmitter Setup (BNF)

### **BNF** Transmitter Setup

**IMPORTANT:** The included receiver has been programmed for operation specifically in this aircraft. The programming in this receiver cannot be changed by the user.

- SAFE Plus Flight modes are selected using Channel 5

**IMPORTANT:** A transmitter with a 2-position Channel 5 switch will only allow the use of position 0 or position 2 flight modes. If possible, assign the Gear channel (CH 5) in your transmitter to a 3-position switch to operate all 3 flight modes.

- The Aux 1 channel (CH 6) is used for AutoLand and should be assigned to a momentary button (I button/ Bind Button)\*

Refer to your transmitter manual for more information regarding switch assigning.

\* The Opterra 1.2m aircraft is not compatible with DX4e or DX5e transmitters.



**CAUTION:** Elevon mixing is handled in the flight controller. Do not use an elevon mix with the BNF Basic flight controller or you may experience loss of control. Loss of control could result in a crash causing personal injury or property damage.

Computerized Transmitter Setup (DX6 Gen2/3, DX6e, DX7 Gen2, DX8 Gen2, DX9, DX18 and DX20)	
Start all transmitter programming with a blank model (do a model reset), then name the model.	
Set Aileron, Elevator, and Rudder Rates to:	HIGH 100% LOW 70%
DX6 DX6e DX8 DX9 DX18 DX20 iX12	1. Go to the SYSTEM SETUP
	2. Set MODEL TYPE: AIRPLANE
	3. Go to CHANNEL ASSIGN: click NEXT to go to Channel Input Config: GEAR: B (Flight Mode), AUX1*: I (AutoLand)
	4. Go to the FUNCTION LIST
	5. Go to Throttle Cut: set to Switch H, Position: -130
Resulting in:	<b>Switch H</b> operates Throttle Cut, position 0 is normal and position 1 cuts power to the throttle. <b>Switch B</b> operates the 3 SAFE Plus modes (0- SAFE/1- SAFE with altitude hold /2- AS3X) <b>Button I</b> commands Traffic Pattern, Loiter and AutoLand when pressed**

Confirm AUX1 is not reversed. If AUX1 is reversed, the ESC and the GPS system will not arm, indicated by full down elevator.\*\*

Dual Rate	High Rate	Low Rate
Aileron	100%	70%
Elevator	100%	70%
Rudder	100%	70%

\*\* BNF with FPV only

## CRSF compatibility

The flight control system included with BNF versions is compatible with the CRSF protocol for alternative receivers. Connect the receiver to the CRSF port and follow the manufacture's instructions for binding. The flight control system will automatically detect CRSF receivers when connected. Always verify correct control surface response to control inputs before flight.

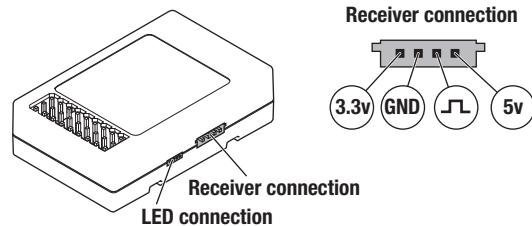

## Transmitter Setup (PNP)

Basic Setup Information			
Dual Rates		Hi Rate	Low Rate
	Ail		24mm
	Ele	8mm	5mm
Control	Elevon mixing required		
Flight Timer Setting	6 minutes		

**IMPORTANT:** Elevon mixing is required for PNP versions of this aircraft. Both ailerons need to operate together as elevators and opposite as ailerons for correct flight controls.

**CAUTION:** Do not attempt to fly the PNP version without a properly configured elevon mix. Failure to set elevon mixing will result in flight controls that do not respond the way a pilot would expect, and the pilot will not be able to control the flight path.



**WARNING:** Before proceeding further, remove the propeller and spinner from the motor shaft. Never attempt to program the radio components, assemble the aircraft, or perform maintenance of any kind without removing the propeller. Serious injury could result if the motor starts inadvertently with the propeller still attached.



1. Remove the M3 X 8 mm screw from the center of the spinner with a 2mm hex wrench.
2. Remove the spinner and propeller.



## Transmitter and Receiver Binding

**CAUTION:** Connecting the battery to the ESC with reversed polarity will cause damage to the ESC, the battery or both. Damage caused by incorrectly connecting the battery is not covered under warranty.

**IMPORTANT:** The included receiver has been programmed for operation specifically in this aircraft. The programming in this receiver cannot be changed by the user.

Refer to your transmitter instructions for binding to a receiver.

The throttle will not arm if the transmitter's throttle stick is not put at the lowest position and the throttle trim centered or lower.

### Binding Procedure Reference Table

1. Make sure the transmitter is powered off.
2. Make sure the transmitter controls are neutral, the throttle is at the lowest position\*, the throttle trim is centered and the aircraft is immobile.
3. Insert a bind plug in the receiver bind port.
4. Connect the flight battery to the ESC. The ESC will produce a long tone followed by a series of additional short tones.
5. The receiver LED will begin to flash rapidly.
6. Power on the transmitter while holding the transmitter bind button or switch.
7. When the receiver binds to the transmitter, the red bind light on the receiver will turn solid and the ESC will produce ascending tones. The tones indicate the ESC is armed, provided the throttle stick and throttle trim are low enough to trigger arming.
8. Remove the bind plug from the bind port. The receiver should retain the binding instructions received from the transmitter until another binding is done.
9. Disconnect the flight battery.
10. Safely store the bind plug (some owners attach the bind plug to their transmitter using two-part loops and clips).

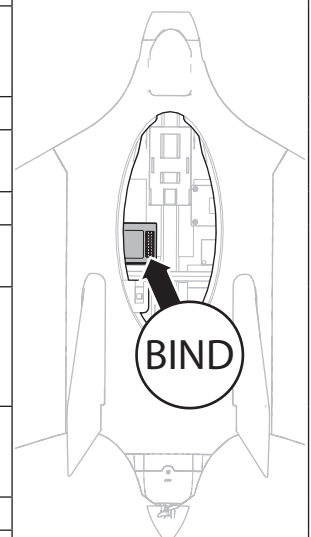

\* The throttle will not arm if the transmitter's throttle stick is not put at the lowest position.

## Model Assembly

### Wing Installation

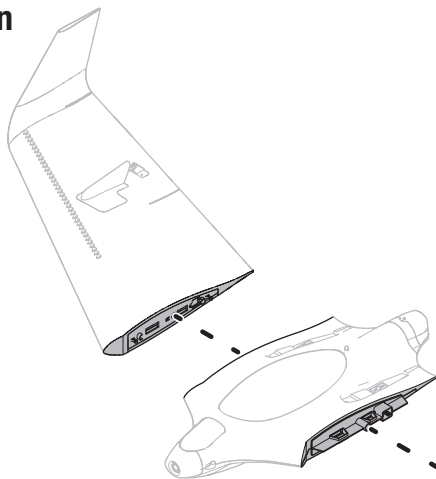

1. Slide the wing tube into the fuselage.
2. Slide the wings onto the wing tube.
3. Press the wing panels together onto the fuselage until the wings click into place.
4. Insert the vertical fins into the pockets on top of the fuselage until the fins click into place. The vertical fins should angle outward.

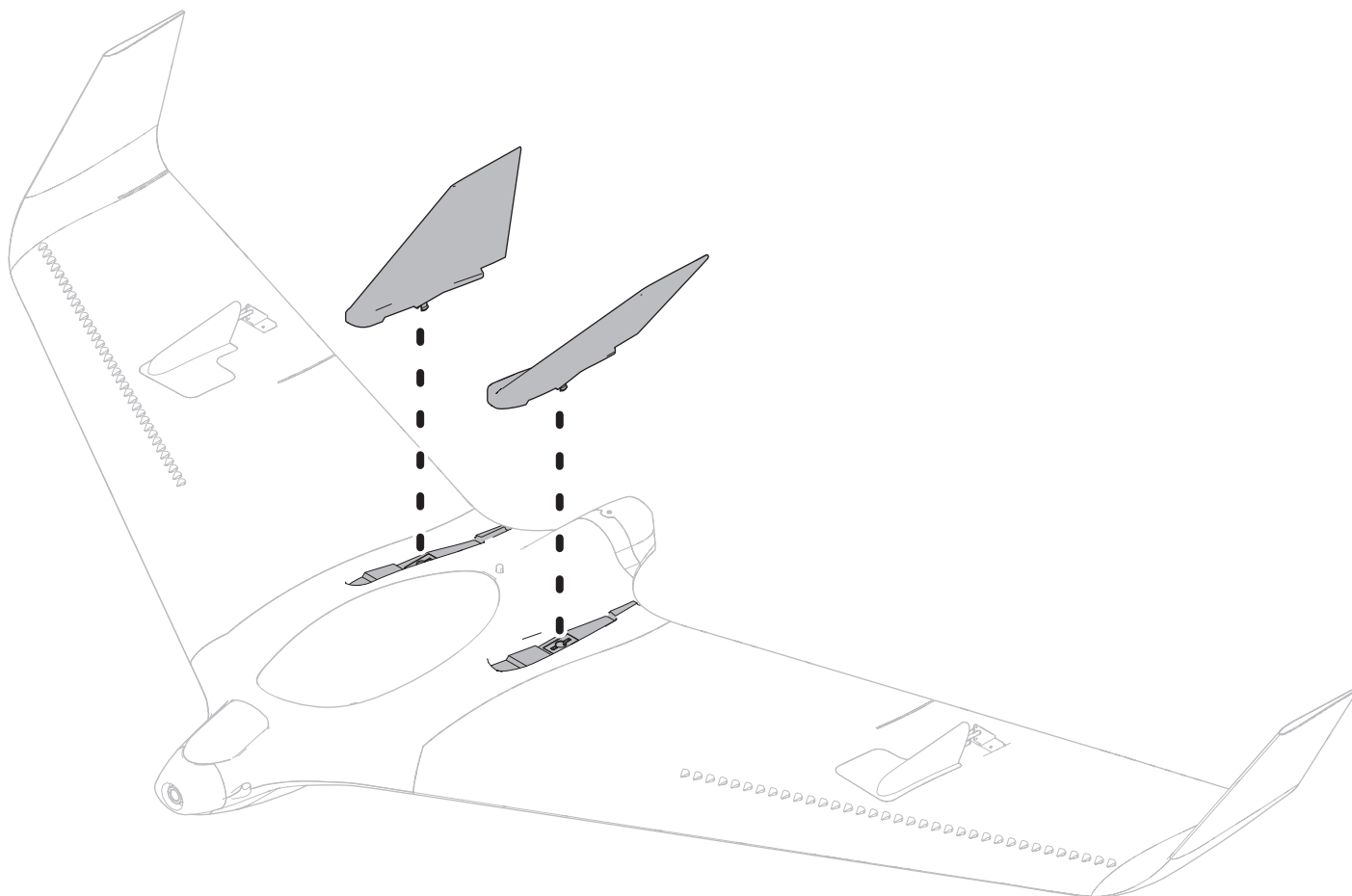
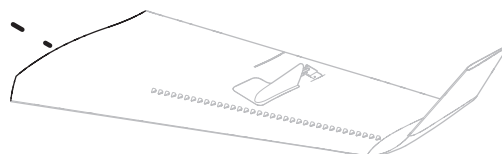

## Battery Installation and ESC Arming

### Battery Selection

We recommend E-flite® 2200-3200mAh 11.1V 3S- 4S 30C Li-Po batteries. If using a battery other than those listed, the battery should be within the range of capacity, dimensions and weight of the E-flite Li-Po battery packs to fit in the fuselage. Be sure the model balances at the recommended CG.

1. Lower the throttle and leave the trim in the neutral position. Power on the transmitter, then wait 5 seconds.
2. Push the canopy latch button (A) to release the canopy and remove.
3. For added security apply the loop side (soft side) of the optional hook and loop tape (B) to the bottom of your battery and the hook side to the battery compartment.
4. Install a fully charged 2200mAh battery (C) all the way forward in the battery compartment as shown.

**IMPORTANT** Adjust the battery position for proper CG accordingly.

5. Connect the battery to the ESC. (the ESC is now armed).
6. Keep the aircraft immobile, upright and level, and away from wind or the system will not initialize.
  - The ESC will sound a series of tones (refer to step 6 of the binding instructions for more information).
  - An LED will light on the receiver.
  - The elevons will cycle up and down two times to indicate that the aircraft has initialized.

If the ESC sounds a continuous double beep after the flight battery is connected, recharge or replace the battery.

7. Reinstall the canopy by inserting the front tab first and pushing down on the back of the canopy until the latch locks.

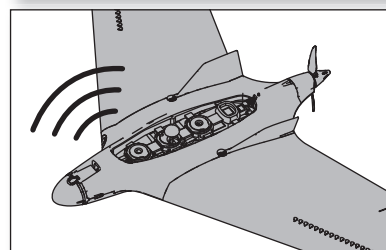
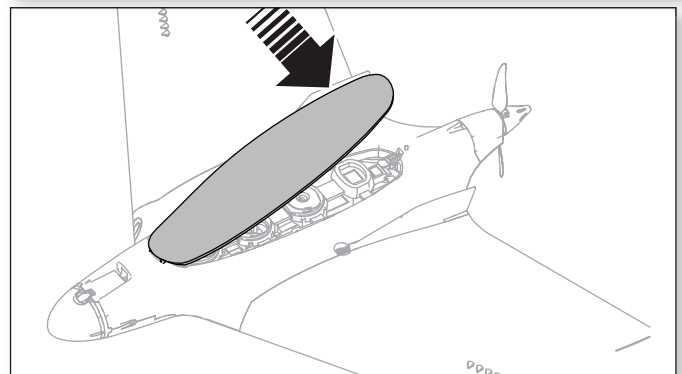
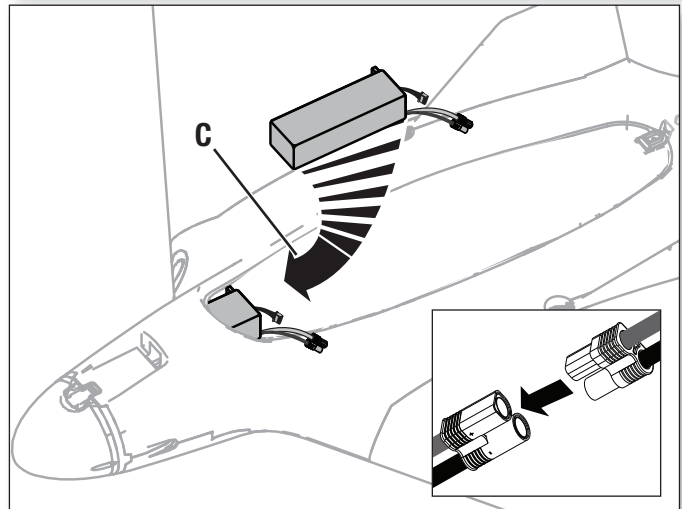
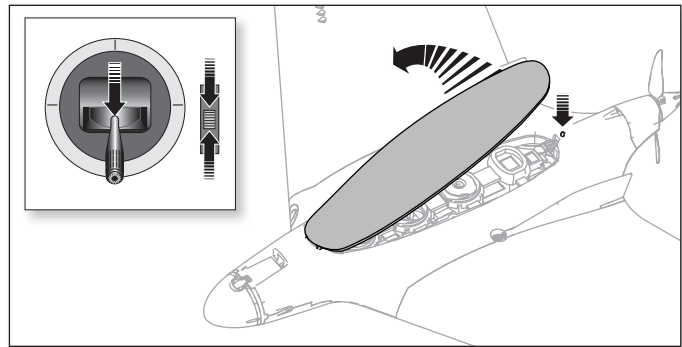

**CAUTION:** Always keep hands away from the propeller. When armed, the motor will turn the propeller in response to any throttle movement.

## Compass Calibration Procedure (BNF with FPV)

Perform the compass calibration outdoors before the first flight or to correct the heading during auto landing if it varies significantly from the heading set during takeoff.

1. Remove the propeller if it is installed or activate throttle cut.
2. With the transmitter trims centered, power on the transmitter and the aircraft while holding the transmitter sticks as shown. The aircraft will indicate the GPS is searching for satellites by cycling the elevator up and down.

3. After satellites are acquired, the aircraft will signal it has entered compass calibration mode by the following:

**Wings on:** The elevons will cycle up and down slowly.

**Wings off:** The red and blue LEDs on the flight controller will flash alternately.

Once in calibration mode, the throttle is not active and the transmitter sticks can be released. The transmitter must remain powered on.

4. Once in calibration mode, rotate the aircraft twice in position 1.
5. Turn the aircraft 90 degrees and rotate it twice in position 2.
6. Turn off the transmitter.
7. Wait 3 seconds and disconnect the flight battery.

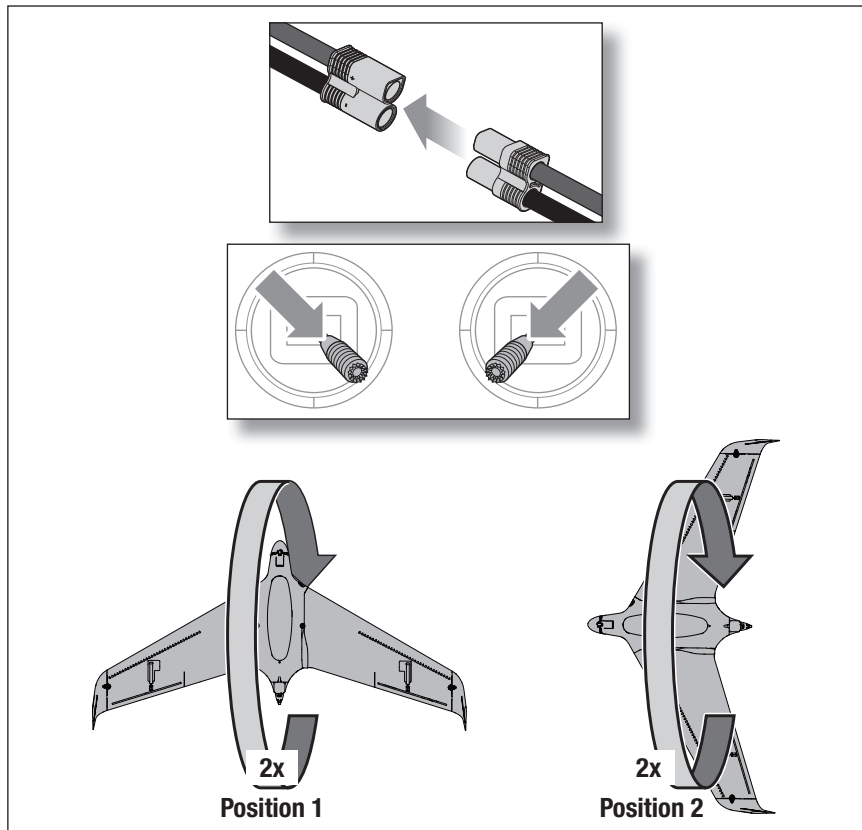

## Choose a Flying Field

**Consult local laws and ordinances before choosing a location to fly your aircraft.**

In order to have the most success and to protect your property and aircraft, it is very important to select a place to fly that is very open.

Remember, your aircraft can reach significant speeds when flying and can cover ground quickly. Plan on flying in an area that gives you more space than you think you need, especially with first flights.

**The site should:**

- Have a minimum of approximately 1300 feet (400m) of clear space in all directions.
- Be clear of people and pets.
- Be free of trees, buildings, cars, power lines or anything that could entangle your aircraft or interfere with your line of sight.

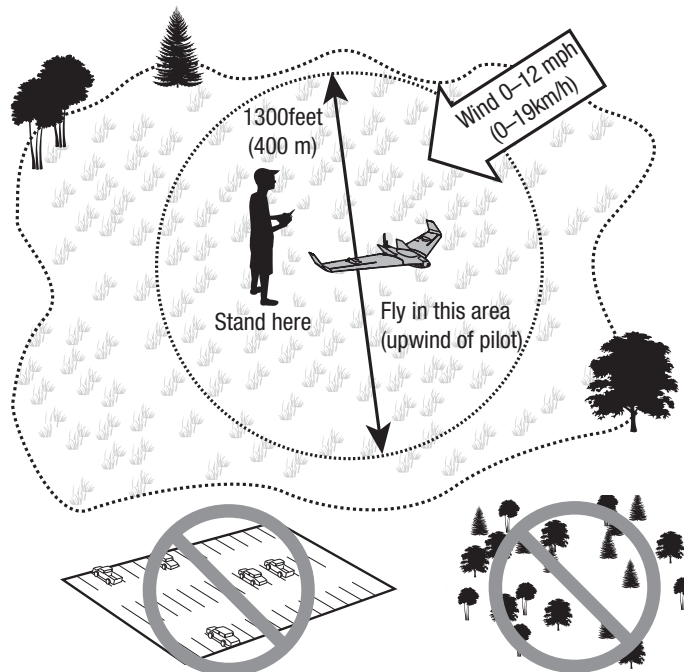



## Video System (BNF with FPV)

The video transmitter installed in the BNF FPV version includes an integrated On Screen Display system (OSD). The OSD takes advantage of the GPS data available on the aircraft to deliver the pilot useful information on the video display. The OSD shows the Flight Mode, Speed and altitude, GPS status, distance to home and an arrow pointing home, time aloft, and voltage. A call sign is also available on the OSD, it is recommended to display your HAM call sign to satisfy amateur radio rules.

The OSD is also helpful during preflight setup because it will tell the pilot the status of GPS systems. It will tell the pilot when the model has a sufficient GPS lock and is ready to fly.

The video transmitter frequency and power output can be set directly from compatible Spektrum transmitters or set in the OSD menu.

### OSD Menu

The OSD has a menu system which has options where the pilot can make changes.

1. To enter the menu the motor must be disarmed.
2. Flip the flight mode switch back and forth twice to enter the menu.
3. To navigate the menu use elevator stick to move up and down through the menu, and aileron stick to move side to side through the menu.

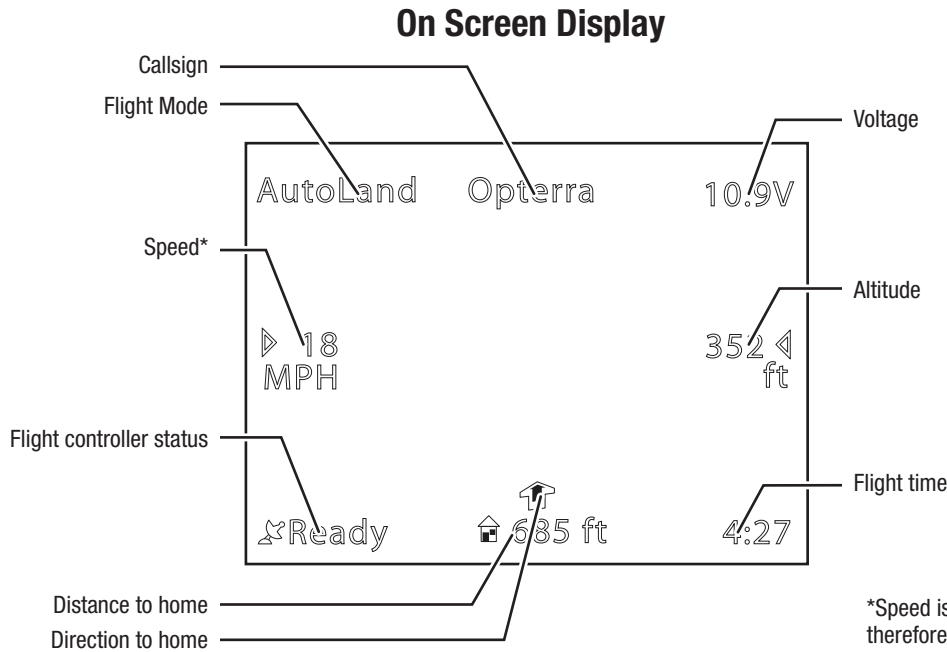

### Flight Controller Status

When powering up the airplane to fly, the OSD will display the flight status in the lower left corner.

When first powered on the OSD will show **INITIALIZING**

When the aircraft has a solid connection to the RC controller and a GPS lock, the OSD will display **READY**

The aircraft will not respond to controls until the status changes to **Ready**. To fly without GPS features see the disabling GPS section of this manual.

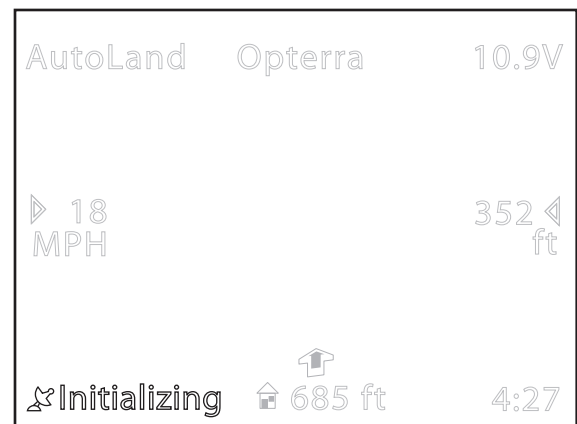

# Using the Video Transmitter

## Specifications

MODEL	SPMVT1001	SPMVT1001EU
Transmitter	Wideband FM Modulate	Wideband FM Modulate
Frequency (MHz)	Wideband FM Modulate	Wideband FM Modulate
Video Format	NTSC	NTSC
Output Impedance	50 Ohm	50 Ohm
Output Power	Off, 25mW, 200mW, 600mW selectable	Off, 25mW
Input Voltage	DC 5V	DC 5V
Camera Output Voltage	DC 5V	DC 5V
Antenna Connector	MMCX	MMCX
Recommended Camera	SPMVC602	SPMVC602

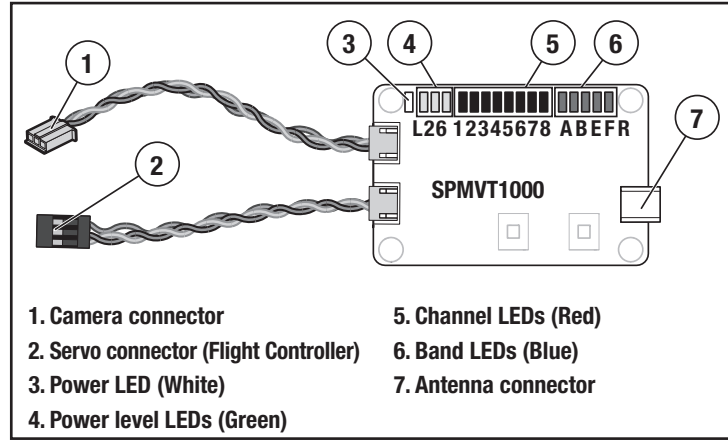

See the frequency table below to find the desired video channel and band. The video transmitter band and power level are changed using the button on the transmitter or the Spektrum™ VTX control system.

Power level LEDs (Green)	SPMVT1001*	SPMVT1001EU†
L	25mW	25mW
2	200mW	N/A
6	600mW	N/A

## Available Frequencies\* (mHz)

SPMVT1001		Channel Number							
Band Number		CH 1	CH 2	CH 3	CH 4	CH 5	CH 6	CH 7	CH 8
A	Band A	5865	5845	5825	5805	5785	5765	5745	5725
B	Band B	5733	5752	5771	5790	5809	5828	5847	5866
E	Band E**	5705	5685	5665	5665	5885	5905	5905	5905
F	FS/IRC	5740	5760	5780	5800	5820	5840	5860	5880
R	RaceBand	5658	5695	5732	5769	5806	5843	5880	5917

\* HAM license required for use in North America, not for use in Europe

\*\* E band Channels 4, 7 and 8 have been removed to prevent transmitting outside of designated Amateur radio frequencies

## EU Frequency Chart†

SPMVT1001EU		Channel Number							
Band Number		CH 1	CH 2	CH 3	CH 4	CH 5	CH 6	CH 7	CH 8
1.	Band A	5865	5845	5825	5805	5785	5765	5745	5745
2.	Band B	5733	5752	5771	5790	5809	5828	5847	5866
4.	FS/IRC	5740	5760	5780	5800	5820	5840	5860	5860
5.	RaceBand	5732	5732	5732	5769	5806	5843	5843	5843

† Frequency sets have been limited to prevent transmitting outside of designated CE Frequencies.

**NOTICE:** Never power on the video transmitter without the antenna installed. Powering on without the antenna will damage the video transmitter. This damage is not covered under warranty.

### Channel and Band Selection:

The LEDs illuminate as indicated on the diagram to show Channel and Band. The buttons will not function when the video transmitter is plugged into the flight controller. Access the frequency and power level options from the Spektrum transmitter control menu, or from the On Screen Display

### Power Level Selection:

All green LEDs off means RF is off, one flashing green LED is Pit mode, one solid green LED is 25mW, two solid green LEDs is 200mW, three solid green LEDs is 600mW.

**IMPORTANT:** Do not kink or cut the antenna adaptor or antenna wires. Antenna wires are coaxial wires, kinks or cuts will degrade performance.

### Spektrum VTX Control:

Spektrum control signals include a special command system to manage frequencies and power output on video transmitters. Compatible video transmitters can be managed from this menu by connecting a signal wire from the aircraft receiver to the video transmitter. See the video transmitter manual for more information.

To apply changes to the video transmitter from the VTX menu of a compatible Spektrum Transmitter with Spektrum AirWare™ firmware:

1. Power on the video transmitter and ensure it is properly connect to the aircraft receiver.
2. From the Model Adjust menu, select Video Tx.
3. Adjust the Band, Channel frequency, Power level and Mode to the desired values. Pit mode sets the video transmitter output to very low power for testing in the pits. Do not attempt to fly using pit mode. Race mode sets the video transmitter output to normal power.
4. Select SEND to apply the changes. The video transmitter must be properly connected and powered on to apply changes.

## Install the Propeller

**WARNING:** Do not install the propeller until the aircraft has been completely assembled, all systems have been checked thoroughly, and you are located at a suitable flying site.

1. Install the spinner backplate, propeller, prop washer and spinner adapter.
  2. Tighten the spinner adapter until the propeller is securely fastened.
  3. Secure the spinner with a 3 x 20mm screw.
- Disassemble in reverse order.

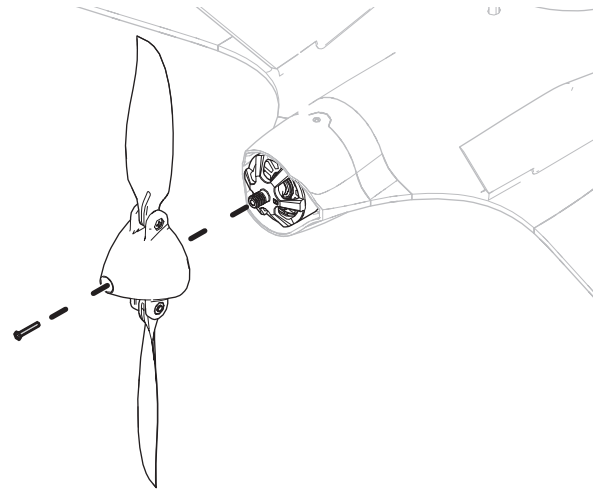

## Center of Gravity (CG)

Establishing the correct center of gravity (CG) is very important for a successful flight experience with this aircraft. The correct CG location is identified by the molded dimples on the bottom of the aircraft. The aircraft should balance slightly nose down with your fingers between the front and rear dimples.

This CG location has been determined with the recommended Li-Po battery (EFLB22003S30) installed all the way forward in the battery tray.

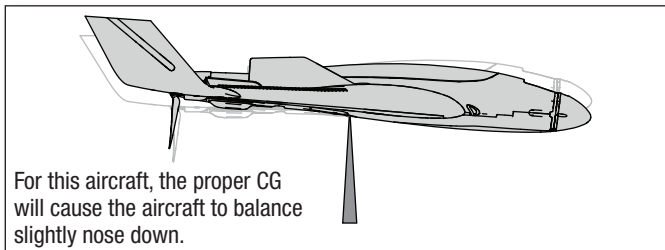
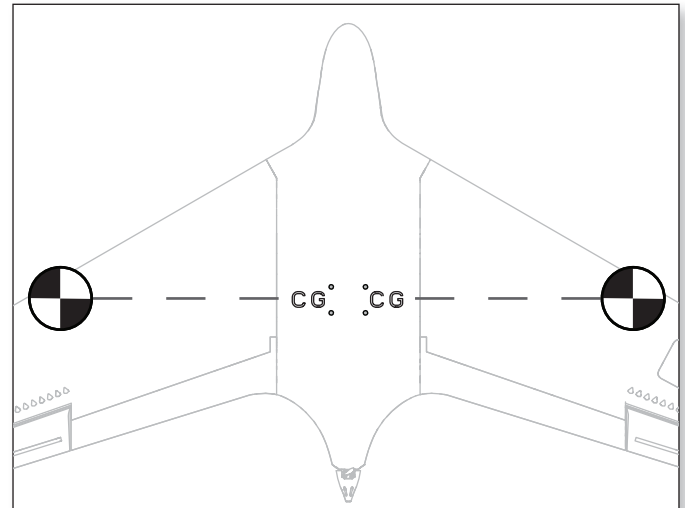

## AS3X/SAFE Control Direction Test

This test ensures that the AS3X® control system is functioning properly. Assemble the aircraft and bind your transmitter to the receiver before performing this test.

1. Flip transmitter switch B to SAFE mode.

**CAUTION:** Keep all body parts, hair and loose clothing away from a moving propeller, as these items could become entangled.

2. Move the entire aircraft as shown and ensure the control surfaces move in the direction indicated in the graphic. If the control surfaces do not respond as shown, do not fly the aircraft. Refer to the receiver manual for more information.

Once the AS3X system is active, control surfaces may move rapidly. This is normal. AS3X remains active until the battery is disconnected.

	Aircraft movement	AS3X Reaction
Pitch		
Roll		

## Flight Preparation

Preflight Checklist	
1.	Find a safe and open flying area
2.	Charge flight battery
3.	Turn on transmitter
4.	Install fully charged flight battery in aircraft
5.	Confirm the CG is within the recommended limits
6.	Ensure the linkages move freely
7.	Perform control direction test
8.	Perform a range check
9.	Perform the compass calibration
10.	Plan flight for flying field conditions
11.	Verify the video display is receiving a solid signal
12.	Install the propeller
13.	Wait for a READY status on the OSD
14.	Set home location and landing direction
15.	Set a flight timer for 5-6 min.
16.	Launch into the wind

## Trimming the Aircraft









### Adjusting Trim in flight

The SAFE Plus flight mode switch should be set to **AS3X mode** (position 2) before adjusting the trims.

Trimming is best done in calm wind conditions.

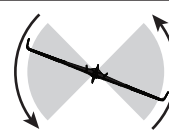
If the aircraft does not fly straight and level at half throttle with the sticks at neutral, fly into the wind and adjust the trim sliders as indicated in the table until the aircraft maintains a reasonably straight and level flight path.

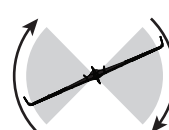
After the aircraft is trimmed in flight, land the aircraft and proceed to the *Manually Adjusting Trim* section to set the trim mechanically.

	Aircraft Drift	Trim Required
Elevator		 Elevator Trim
		 Elevator Trim
Aileron		 Aileron Trim
		 Aileron Trim

### Manually Adjusting Trim

**WARNING:** Do not perform any maintenance with the propeller installed on the aircraft. Serious injury or property damage could result from the motor starting inadvertently.

The SAFE Plus flight mode switch should be set to **Experienced mode** (position 2) before manually adjusting the trim settings.

The aircraft should be kept still while performing manual adjustment of trim.

With the trim settings from the trim flight still set in the transmitter, take note of the positions of each of the control surfaces, one at a time.

Adjust the clevis on each control surface to position the surface the same as it was with the trim offset.

1. Remove the clevis from the control horn.
2. Turn the clevis (as shown) to lengthen or shorten the pushrod.
3. Close the clevis onto the control horn and slide the tube towards the horn to secure the clevis.
4. Move to the next control surface.

When you have all of the surface trims centered, return the trim settings on the transmitter to neutral by pushing the trim buttons for each surface until the transmitter emits a loud beep indicating center trim.

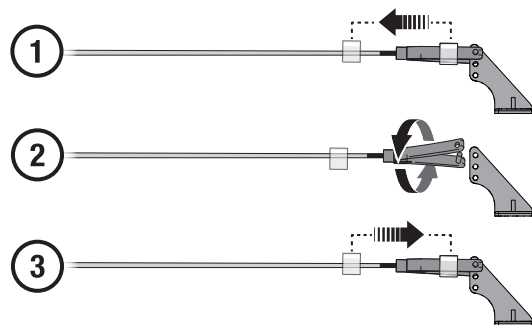

# Flying

## SAFE Technology Flight Modes

Change between SAFE Plus flight modes by changing the flight mode switch position.

### Safe Mode (Position 0):

- Below approx. 50 feet (15m), pitch (nose up and down) and roll (wing tips up and down) angles are limited to help you keep the aircraft airborne.
- Above approximately 50 feet (15m), pitch and roll control are increased slightly.
- At any time release both sticks to activate panic recovery mode for self-leveling.

### Altitude Hold Mode (Position 1):

- Same as beginner mode, and holds the altitude.
- Climb or descend with Elevator control, altitude is held when elevator is neutral.

### AS3X Mode (Position 2):

- Unlimited Flight Envelope.
- Switch to beginner mode at any time and release the control sticks for self-leveling.

**NOTICE:** If the aircraft is upside down when the self leveling is applied, sufficient altitude is required for the aircraft to return to straight and level flight.

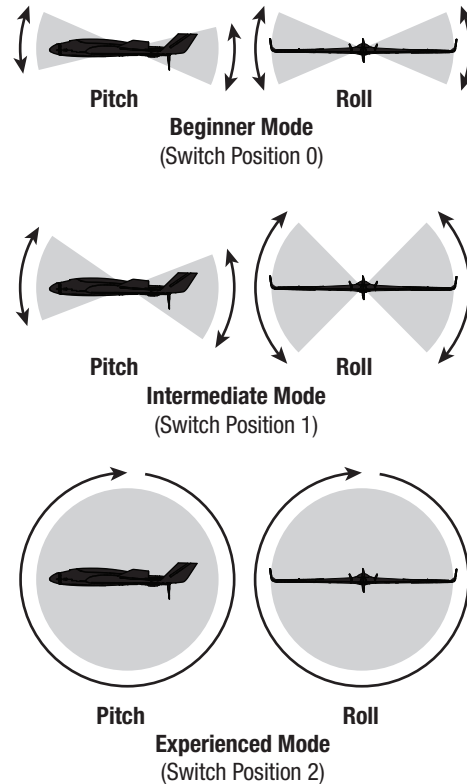

## Virtual Fence Flight Modes (BNF with FPV only)

Flight Mode	TX Switch Position
SAFE	FM 0 (Switch B)
SAFE with ALT hold	FM 1 (Switch B)
AS3X	FM 2 (Switch B)
Holding Pattern*	Press and release the AutoLand button once
Loiter*	Press and release the AutoLand button twice
AutoLand*	Press and hold (3 seconds) the AutoLand Button

\* Changing the flight mode switch or pressing the AutoLand button will interrupt Holding Pattern, Loiter, or AutoLand Modes.

### Compass Calibration

Compass calibration should be performed before the first flight and whenever the aircraft is flown at a new location. Refer to the product manual for complete compass calibration instructions.

### Deactivating GPS

Push and hold the HP/AL (bind) button and fully cycle the flight mode switch 3 times. Power cycle the aircraft to re-activate.

### Virtual Fence Selection (Mode 2 transmitter shown)

Hold the transmitter sticks as shown while the aircraft GPS system is initializing to change the active Virtual Fence Mode.

Virtual Fence Mode	Transmitter Stick Position
<b>Virtual Fence OFF</b> <ul style="list-style-type: none"> <li>• Low throttle</li> <li>• Full right aileron</li> <li>• Full up elevator</li> </ul>	
<b>Circle Virtual Fence, Small</b> <ul style="list-style-type: none"> <li>• Low throttle</li> <li>• Full left aileron</li> <li>• Full up elevator</li> </ul>	
<b>Circle Virtual Fence, Large (Default)</b> <ul style="list-style-type: none"> <li>• Low throttle</li> <li>• Full left aileron</li> <li>• Full down elevator</li> </ul>	
<b>Airfield Virtual Fence</b> <ul style="list-style-type: none"> <li>• Low throttle</li> <li>• Full right aileron</li> <li>• Full down elevator</li> </ul>	

## Virtual Fence Mode (BNF with FPV)



**CAUTION:** Keep aircraft away from magnetic sources such as cameras, camera mounts, speakers ect. These may interfere with the GPS system and loss of control may result.

Your aircraft uses GPS to establish a home location and a virtual fence to keep the aircraft within a given distance from the home location. While flying, the aircraft will automatically turn around and fly back towards the home location if it approaches the edge of the virtual fence. Once back inside the fence, the aircraft will “wag” its wings, indicating full control has been given back to the pilot.

The Virtual Fence feature is active in all SAFE Plus flight modes, provided the GPS function is active.

There are 4 variations of Virtual Fence mode, which are selectable from the transmitter while the aircraft GPS system initializes.

**Virtual Fence Off:** turns off the Virtual Fence function.

**Circle Virtual Fence, Small (Default):** sets the virtual fence in a circle with a radius of approximately 500 ft (150m) from the home location.

**Circle Virtual Fence, Large:** sets the virtual fence in a circle with a radius of approximately 820 ft (250m) from the home location.

**Airfield Virtual Fence:** sets the virtual fence to an area approximately 400m long x 200m wide and establishes a “no fly zone” approximately 13 feet inside of the center line of the set aircraft heading to keep the aircraft from flying behind the pilot or over a pit area.

Once a Virtual Fence mode is chosen, the aircraft will remain in that mode until another mode is chosen. It is not necessary to select the Virtual Fence mode every time the aircraft is powered on.

Circle Virtual Fence

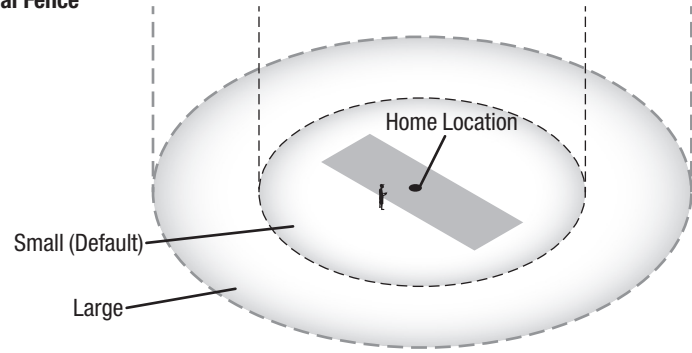

Airfield Virtual Fence

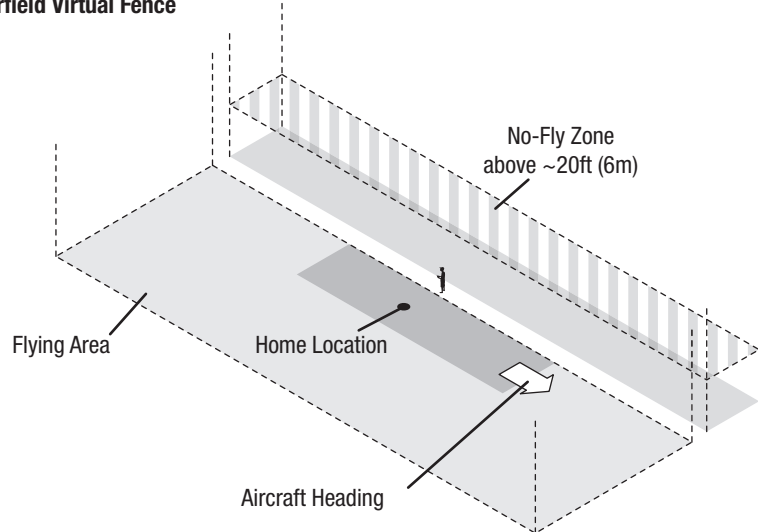

**WARNING:** Never attempt to fly under the no fly zone. The bottom of the no fly zone is elevated to only allow for taxiing of the aircraft in the pit area of the airfield. Due to variances in the barometric sensor, attempting to fly in this area may cause the aircraft to suddenly fly back toward the home location, during which time the pilot will have no control over the aircraft until the aircraft reaches the home location. The pilot will have no way to avoid any obstacles between the no fly zone and the home location.

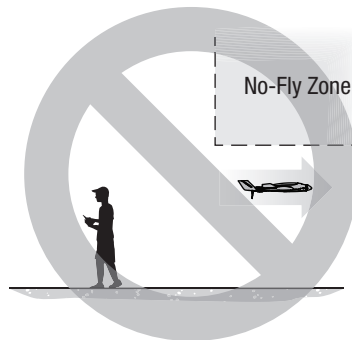

## Power On, GPS Initialization and Establishing Home Location (BNF with FPV)

**CAUTION:** Keep aircraft away from magnetic sources such as cameras, camera mounts, speakers ect. These may interfere with the GPS system and loss of control may result.

1. Power on the transmitter.
  2. Install a fully charged flight battery, following the instructions in the *Install the Flight Battery* section. The control surfaces will go move up and down, indicating the aircraft is searching for an RF link.
  3. Once the RF link has been established, the elevator will move up and down slowly, indicating the aircraft is searching for GPS lock.
    - If you wish to change the virtual fence mode, input the transmitter stick commands as described in the *Virtual Fence Mode and GPS* section while the aircraft is searching for GPS lock.
    - The elevator movement will speed up as satellites are located.
    - The elevator will quickly move and then center to indicate GPS lock.
  4. The ESC will arm. Place the aircraft in the desired home location, pointing into the wind and the desired takeoff direction.
  5. When in the desired location and direction, press and hold the HP/AL (bind) button to set the home location.
    - If either of the circle Virtual Fence modes are active or if virtual fence is off, all control surfaces will wag, indicating the aircraft is ready for flight. Release the HP/AL (bind) button.
    - If the Airfield Virtual Fence mode is active, only the ailerons will wag left and right. Release the HP/AL (bind) button. You must then indicate where the flying side of the airfield is in relation to the home location. The throttle will be inactive until the flying side direction is set. Set the flying side direction by moving the aileron stick either left or right:
      - If the flying side is off the right wing of the aircraft as it sits in the home location, push the aileron stick right.
      - If the flying side is off the left wing as the aircraft sits in the home location, push the aileron stick left.
- Once the home location and flying location is set, all surfaces will wag, indicating the aircraft is ready for flight.

## LED Display (BNF with FPV only)

Flight control status is shown on the external LED display in addition to the OSD.

LED	Indicates
Green flashing	Waiting for GPS lock
Blue, red and green flashing	GPS lock acquired, waiting for home position
Blue solid	SAFE
Purple solid	SAFE with ALT hold
Red solid	AS3X

## Throttle Cut in GPS modes (BNF with FPV only)

When the aircraft is in a GPS assisted mode (Loiter, Holding Pattern, or AutoLand), the motor will not respond to throttle stick commands. Activate the throttle cut function to stop the motor in GPS modes. For throttle cut to function properly, the throttle channel needs to go to -130% when throttle cut is activated.

### Takeoff

Set the flight mode switch to Beginner Mode (position 0) for your first flights.

Set a flight timer for 5-6 minutes.

### Hand Launch

Once you have established a home position and the aircraft is ready for flight, use the following steps.

1. Grip the aircraft under the fuselage, behind the wing struts.
2. Slowly advance the throttle to 100%.
3. Throw the aircraft slightly nose up and directly into the wind (less than 5–7 mph (8–11km/h)).

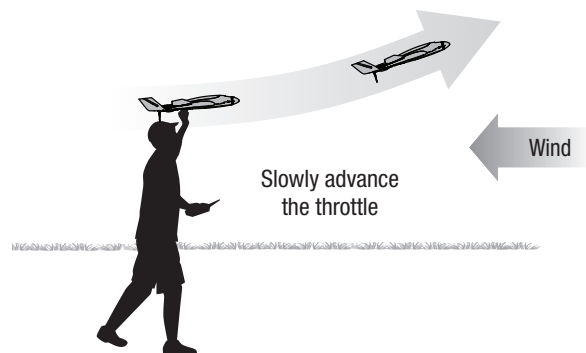

## Flight Patterns (BNF with FPV)

### Holding Pattern Mode

If at anytime the aircraft seems too far away, press and release the AutoLand button on the transmitter.

The aircraft will maneuver to an altitude of approximately 120 feet (36m) and begin to fly a circular pattern over the home location.

If Airfield Virtual Fence mode is active, the aircraft will fly to approximately 120 ft (36m) altitude and fly a circular pattern about 100 ft (30m) in front of the home location.

The aircraft flies fully autonomously when HP mode is active. The transmitter sticks have no control.

### Loiter Mode

Press and release the AutoLand button twice time to enter loiter mode. In Loiter Mode the aircraft will begin circling the the point in the sky it is occupying when Loiter is activated. The altitude and location of the loiter can be adjusted with flight controls while the aircraft is in this mode, the model will resume Loiter Mode after controls are released.

**NOTICE:** As a safety precaution, Holding Pattern and Loiter mode will not function when the aircraft is below an altitude of approximately 20 ft (6m).

To deactivate Holding Pattern or Loiter Modes and regain control, press and release the AutoLand button again or change flight modes.

**IMPORTANT:** When the Holding Pattern or Loiter feature is activated, the aircraft should immediately respond to the command. If the aircraft does not respond immediately, GPS signal may have been lost. In this case, the aircraft will have to be flown back to the home location manually.

### Failsafe

If at anytime the aircraft loses radio connection, the aircraft will activate Holding Pattern mode until it re-establishes radio connection. If radio connection is not regained, the aircraft will land near the takeoff location as in AutoLand mode.

If radio connection is lost while the aircraft is already in Holding Pattern Mode, the aircraft will circle for approximately 35 seconds and then set up to land as in AutoLand mode.

**NOTICE:** If a crash is imminent, activate throttle cut or quickly lower the throttle and throttle trim. Failure to do so could result in extra damage to the airframe, as well as damage to the ESC and motor.

### Loiter and Holding Pattern Mode

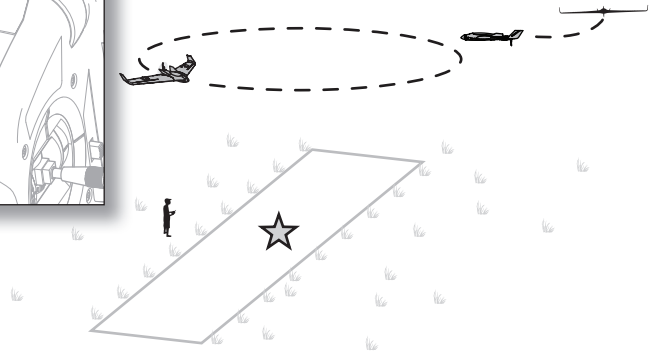
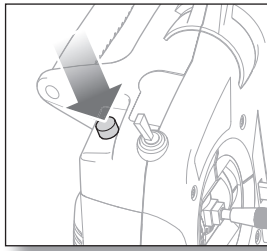

### Holding Pattern Mode, Airfield Virtual Fence Active

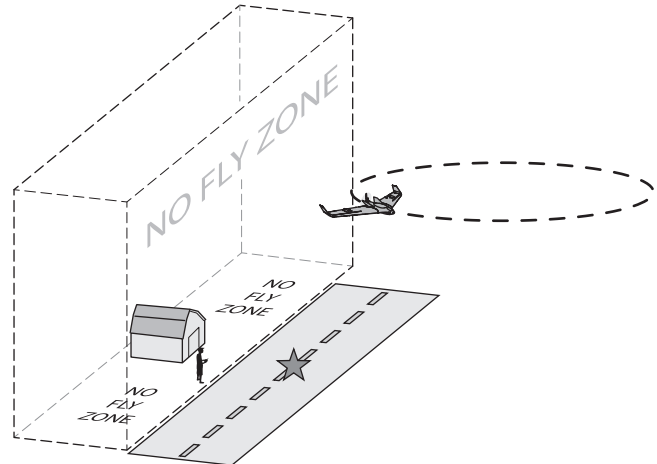

### Low Voltage Cutoff (LVC)

LVC is a function built into your ESC to protect the battery from over-discharge. When the battery charge is low, LVC limits power supplied to the motor. The aircraft will begin to slow and you will hear the motor pulse. When the motor power decreases, land the aircraft immediately and recharge the flight battery.

**NOTICE:** Repeated flying to LVC will damage the battery.

Disconnect and remove the Li-Po battery from the aircraft after use to prevent trickle discharge. Charge your Li-Po battery to about half capacity before storage. During storage, make sure the battery charge does not fall below 3V per cell.

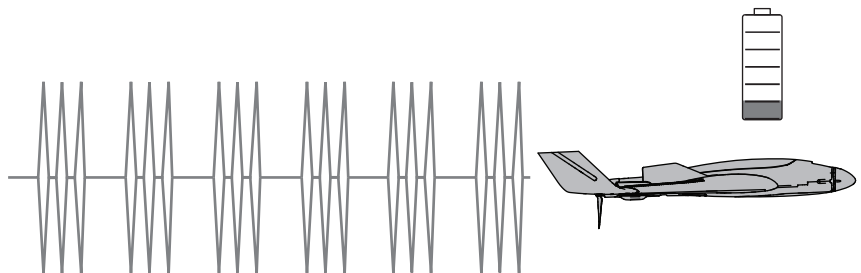



## Landing

When it is time to land the aircraft, either activate AutoLand mode or land the aircraft manually.

### AutoLand Mode (BNF with FPV)

To activate AutoLand mode, press and hold the HP/AL (bind) button for 3 seconds. The aircraft will immediately turn to align itself for an upwind approach and maneuver to an altitude of approximately 65 ft (20m) and 295 ft (90m) downwind from the takeoff point. The aircraft will then turn into the wind and begin the final approach.

**NOTICE:** As a safety precaution, AutoLand mode will not initiate when the aircraft is below an altitude of approximately 20ft (6m).

**IMPORTANT:** When the AutoLand feature is activated, the aircraft will immediately respond to the command. If your aircraft does not respond immediately, GPS signal may have been lost. In this case, the aircraft will have to be flown back and landed manually.

The aircraft will land into the wind near your takeoff point and come to a complete stop.

Press and release the HP/AL (bind) button or change flight modes at anytime to abort the AutoLand approach.

**IMPORTANT:** AutoLand mode does not have the ability to avoid obstacles. Ensure that your flying location is free of obstacles (trees, buildings, etc) before you start flying. Remain alert during the AutoLand process in the event it becomes necessary to assist during or abort the landing approach.

**CAUTION:** Never attempt to catch a flying aircraft in your hands. Doing so could cause severe personal injury and damage to the aircraft.

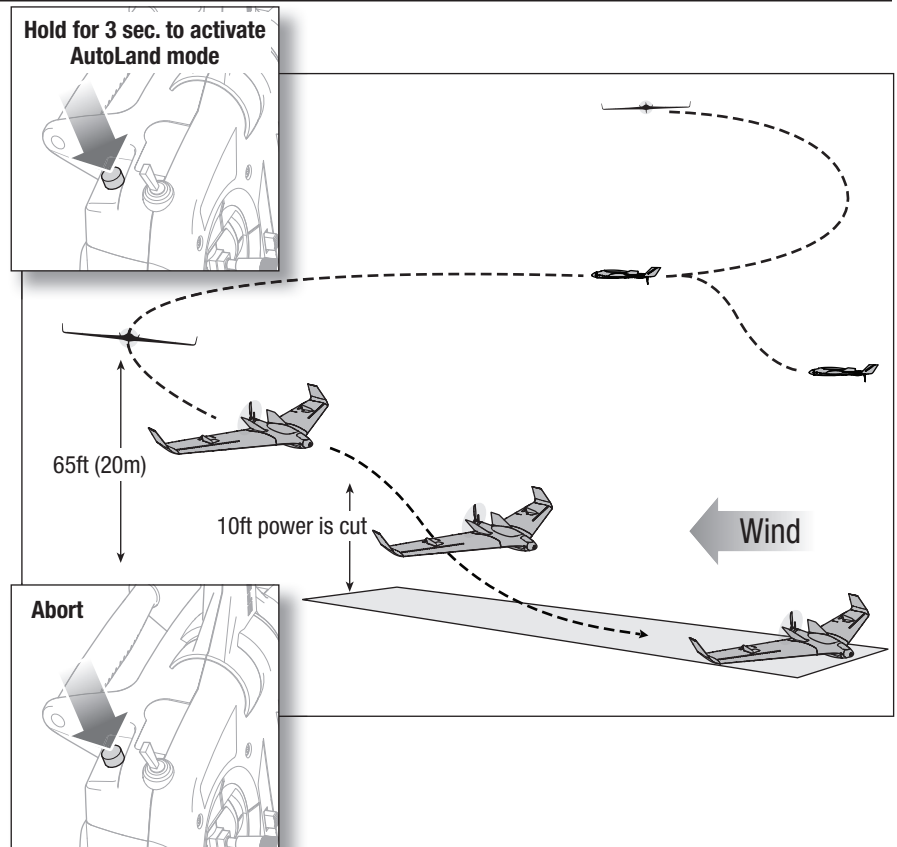

### Assisting AutoLand Mode (BNF with FPV)

No stick inputs are required when AutoLand is activated. However, stick inputs can be used at anytime during AutoLand to avoid an obstacle, lengthen the landing or smooth the final flare on landing.

#### Aileron stick:

Use the aileron stick to steer left or right to avoid an obstacle or make slight heading adjustments when on final approach. When aileron is given, the throttle will automatically advance slightly. Release the aileron stick and the system will take over full control.

#### Throttle stick:

Use the throttle stick to set a throttle max point. When elevator stick input is given, the throttle will go to the max point.

#### Elevator stick:

**Up elevator:** Allows the aircraft to stretch its approach by gaining altitude. When up elevator is applied the throttle increases to the throttle max point that you have established with the throttle stick.

As the aircraft passes over the runway threshold, pull the throttle stick fully back and use up elevator to flare the aircraft to a soft touch down on the runway. This is the best practice for landings and will help prevent accidental propeller strikes.

**Down elevator:** Allows the aircraft to stretch its approach without gaining or losing altitude. When down elevator is applied, the throttle increases to the throttle max point that you have established with the throttle stick without gaining or losing altitude. As soon as the right stick is centered, the system will take over full control again.

**Example:** When landing into a headwind, set the throttle stick to approximately 3/4 power. When the elevator stick is moved to extend the landing approach, the power will only progress to 3/4 power. Set to a higher throttle point in stronger wind or lower throttle point in low wind.

## Landing

### Landing Manually

If it is necessary to land the aircraft manually:

1. Reduce the throttle to around 50% to slow the airspeed.
2. Fly the aircraft downwind past the end of the runway.
3. Turn the aircraft into the wind and line the aircraft up with the runway center line.
4. Decrease the throttle further and begin descending towards the runway, keeping the wings level during approach. Try to have the aircraft at 10ft altitude as it passes over the threshold of the runway.
5. As the aircraft passes over the threshold of the runway decrease the throttle fully.
6. Just as the aircraft is about to touch down, gently pull back on the elevator to raise the nose and flair for a gentle landing.

**NOTICE:** If a crash is imminent, activate throttle hold or quickly lower the throttle and throttle trim. Failure to do so could result in extra damage to the airframe, as well as damage to the ESC and motor.

**IMPORTANT:** When finished flying, never keep the aircraft in the sun. Do not store the aircraft in a hot, enclosed area such as a car. Doing so can damage the foam.

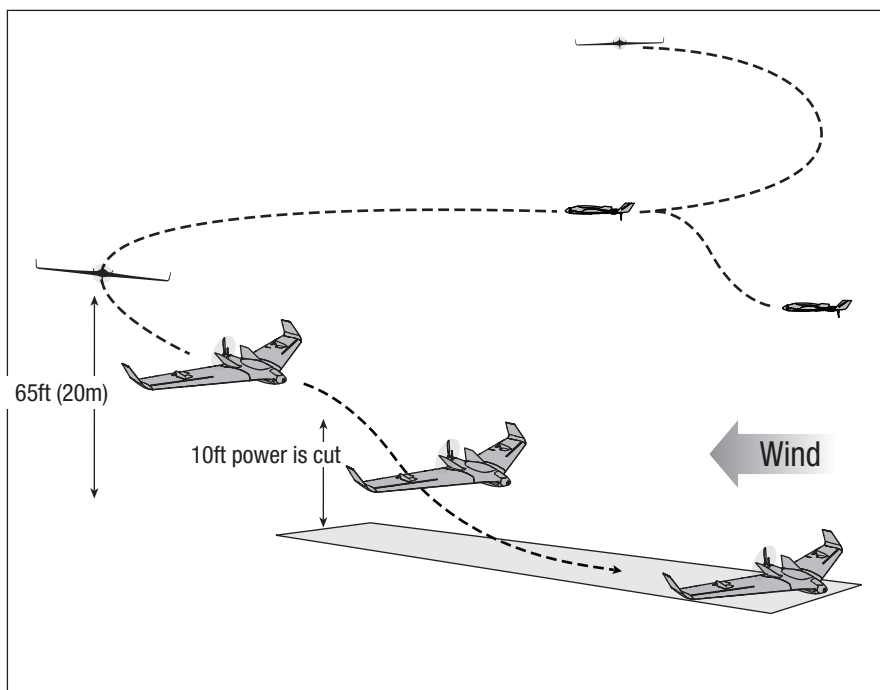

### Post Flight Checklist

1. Activate Throttle Cut.
2. While avoiding the area of the propeller and prop arc, disconnect the flight battery from the aircraft (Required for Safety)
3. Remove the flight battery from the aircraft
4. Power off the transmitter
5. Recharge the flight battery
6. Inspect the airframe for loose or damaged parts
7. Repair or replace all damaged parts
8. Store flight battery apart from aircraft and monitor the battery charge
9. Make note of flight conditions and flight plan results, planning for future flights

## Deactivating GPS (BNF with FPV)



**WARNING:** Do not perform this or any other equipment test with the propeller installed on the aircraft. Serious injury or property damage could result from the motor starting inadvertently.

The GPS system is activated from the factory. If for any reason you wish to deactivate the GPS system, such as to perform a control direction test indoors or to simply enjoy the aircraft without GPS features, follow the directions below:

1. Ensure that your transmitter is bound to the aircraft. If necessary, refer to the *Transmitter and Receiver Binding* section.
2. Power on the transmitter.
3. Power on the aircraft. After the aircraft finds the RF signal, the elevator will start to move up and down slowly, indicating the GPS system is searching for satellites.
4. Press and hold the HP/AL (bind) button and cycle the flight mode switch fully 3 times. The elevons will stop moving, indicating the GPS system is deactivated.

To reactivate the GPS system, power cycle the aircraft.

**IMPORTANT:** When the GPS system is deactivated, the aircraft's Holding Pattern, AutoLand and Virtual Fence modes will not function.

## Service and Repairs

**WARNING:** Do not perform this or any other equipment maintenance with the propeller installed on the aircraft. Serious injury or property damage could result from the motor starting inadvertently.

**NOTICE:** Crash damage is not covered under warranty.

**NOTICE:** After any impact or replacement always ensure the flight controller/GPS module is secure in the fuselage. If you replace the flight controller, install the new flight controller in the same location and orientation as the original or damage may result.

Thanks to the EPO foam material the aircraft is made of, repairs can be made using virtually any adhesive (hot glue, regular CA [cyanoacrylate adhesive], epoxy, etc). When parts are not repairable, see the *Replacement Parts* list for ordering by item number.

### Service of Power Components

**WARNING:** Always disconnect the flight battery from the model before removing the propeller.

#### Disassembly

1. Remove the screw (A) and spinner (B).
2. Remove the 4 screws (C) holding the motor mount (D) to the fuselage.
3. Disconnect the motor wires from the ESC wires.
4. Remove the 4 screws (E) holding the motor (F) to the motor mount.

Assemble in reverse order.

#### Assembly Tips

- Correctly align and connect the motor wire colors with the ESC wires.

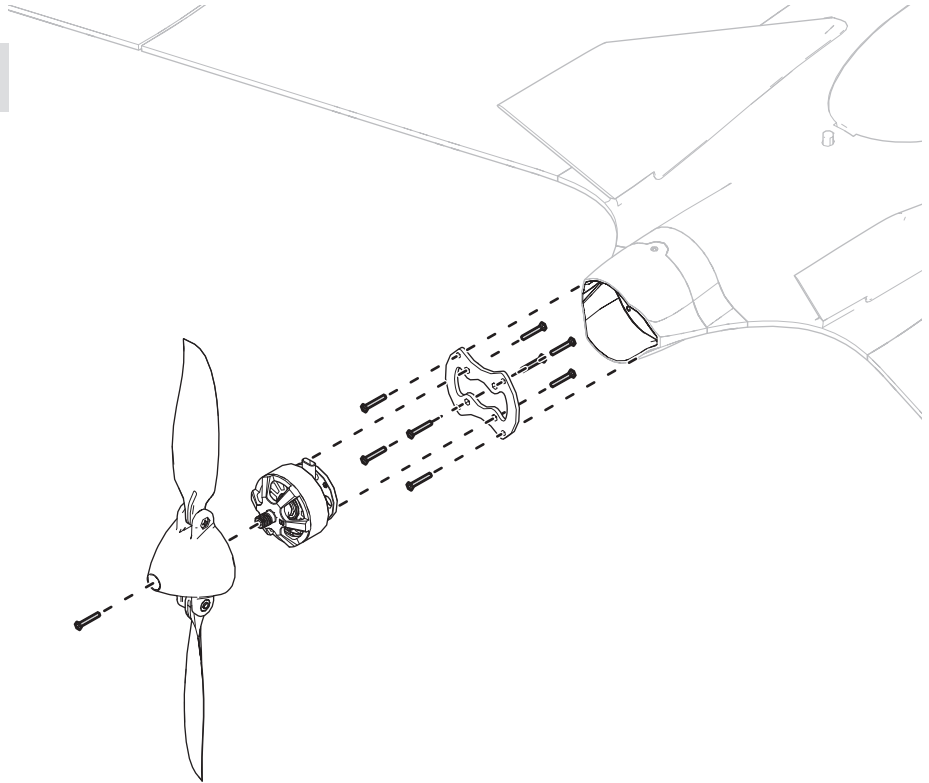

## Upgrading PNP and BNF Basic

Users who wish to upgrade to the BNF with FPV system can add the necessary replacement parts and achieve the same functions. Compass calibration is required after installing a new GPS/compass.

Required parts:

- SPMA3235 Flight Controller
- SPMA3173 GPS Module
- SPMVC602 FPV Camera
- SPMVT1001/SPMVT1001EU VTX

#### Flight Controller Plug Connections

Bind - Bind

- 1- Throttle
- 2- Right Elevon
- 3- Left Elevon
- 4- N/A
- 5- N/A
- 6- Video Transmitter
- 7- Voltage
- 8- Current

#### SPMA3235 Flight Controller Connections

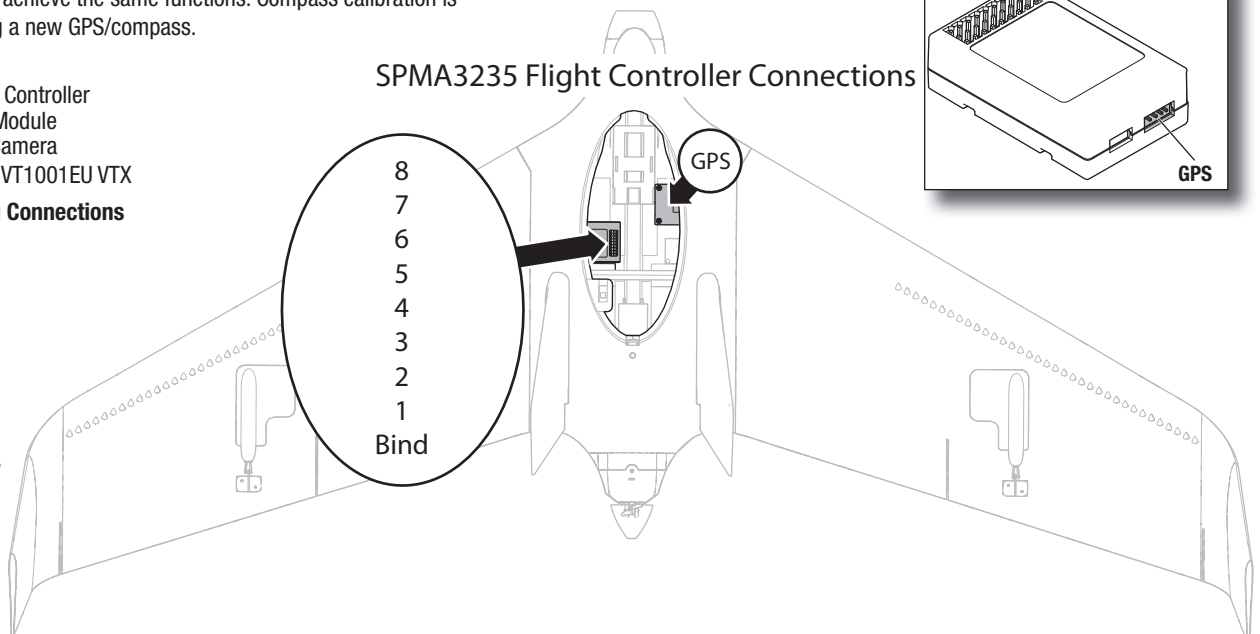

## Trouble Shooting Guide

Problem	Possible Cause	Solution
Aircraft does not operate	There is no link between the transmitter and receiver	Re-Bind the system following directions in this manual
	No GPS lock. (or operating indoor without disabling GPS)	Move to outside and power on aircraft or disable GPS in the aircraft
	Transmitter AA batteries are depleted or installed incorrectly as indicated by a dim or unlit LED on the transmitter or the low battery alarm	Check polarity installation or replace with fresh AA batteries
	No electrical connection	Push connectors together until they are secure
	Flight battery is not charged	Fully charge the battery
Aircraft keeps turning in one direction	Crash has damaged the radio inside the fuselage	Replace the fuselage or receiver
Aircraft does not land on heading set on initial takeoff	Aileron or aileron trim is not adjusted correctly	Adjust stick trims or manually adjust aileron positions
GPS Function not operating properly	Compass is out of calibration	Calibrate the compass using the "Compass Calibration Procedure" located in this manual
Aircraft is difficult to control	The compass has been exposed to a magnetic source.	Deactivate GPS system while in flight and land the aircraft. Remove any possible magnetic sources such as cameras, camera mounts, speakers ect. Unplug and reconnect flight battery to reactivate GPS system for next flight. Perform compass calibration before flying again.
	Wing or tail is damaged	Replace damaged part
	Damaged propeller	Land immediately and replace damaged propeller
Aircraft nose rises steeply at half throttle	Center of Gravity is behind the recommended location	Shift battery forward, do not fly until correct Center of Gravity location is achieved
	Wind is too gusty or strong	Postpone flying until the wind calms down
	Elevator is trimmed 'up' too much	If trim must adjusted more than 4 clicks when pushing the trim button, adjust push rod length
Aircraft will not climb	Battery is not installed in the correct position.	Move forward approximately 1/2"
	Battery is not fully charged	Fully charge battery before flying
	Elevator may be trimmed 'down'	Adjust elevator trim 'up'
Aircraft is difficult to launch in the wind	Propeller damaged or installed incorrectly	Land immediately, replace or install propeller correctly
	Launching the aircraft down wind or into a cross wind	Always launch the aircraft directly into the wind
Flight time is too short	Battery is not fully charged	Recharge battery
	Flying at full throttle for the entire flight	Fly at just above half throttle to increase flying time
	Wind speed too fast for safe flight	Fly on a calmer day
	Propeller damaged	Replace propeller
Aircraft vibrates	Propeller, spinner or motor damaged	Tighten or replace parts
Rudder, ailerons or elevator do not move freely	Damaged or blocked push rods or hinges	Repair damage or blockage
Aircraft will not Bind (during binding) to transmitter	Transmitter is too near aircraft during binding process	Move powered transmitter a few feet from aircraft, disconnect and reconnect battery to aircraft
	Aircraft or transmitter is too near a large metal object, wireless source or another transmitter	Move the aircraft and transmitter to another location and attempt binding again
	Bind plug is not installed correctly	Install bind plug and bind aircraft to transmitter
	Flight battery/Transmitter battery charge is too low	Replace/recharge batteries
Aircraft will not connect (after binding) to transmitter	Transmitter is too near aircraft during connecting process	Move powered transmitter a few feet from aircraft, disconnect and reconnect battery to aircraft
	Aircraft or transmitter is too near a large metal object, wireless source or another transmitter	Move the aircraft and transmitter to another location and attempt connecting again
	Bind plug is left installed	Rebind transmitter to aircraft and remove bind plug before cycling power
	Aircraft battery/Transmitter battery charge is too low	Replace/recharge batteries
	Transmitter may have been bound to a different model (using different DSM Protocol)	Bind aircraft to transmitter
After being properly adjusted, elevons are not in neutral position when battery is plugged in	Model was moved during initial power on	Unplug flight battery and reconnect, keeping model immobile for at least 5 seconds
Virtual Fence modes will not change between modes correctly	Dual rates set incorrectly in transmitter setup	The dual rates should not be set lower than 70% for low rate. Set all low rates to 70% or higher

# AMA National Model Aircraft Safety Code

Effective January 1, 2014

## A. GENERAL

A model aircraft is a non-human-carrying aircraft capable of sustained flight in the atmosphere. It may not exceed limitations of this code and is intended exclusively for sport, recreation, education and/or competition. All model flights must be conducted in accordance with this safety code and any additional rules specific to the flying site.

1. Model aircraft will not be flown:
  - b. In a careless or reckless manner.
  - c. At a location where model aircraft activities are prohibited.
4. Model aircraft pilots will:
  - a. Yield the right of way to all man carrying aircraft.
  - b. See and avoid all aircraft and a spotter must be used when appropriate (AMA Document #540-D.)
  - c. Not fly higher than approximately 400 feet above ground level within three (3) miles of an airport, without notifying the airport operator.
  - d. Not interfere with operations and traffic patterns at any airport, heliport or seaplane base except where there is a mixed use agreement.
  - e. Not exceed a takeoff weight, including fuel, of 55 pounds unless in compliance with the AMA Large Model Aircraft program. (AMA Document 520-A.)
  - f. Ensure the aircraft is identified with the name and address or AMA number of the owner on the inside or affixed to the outside of the model aircraft. (This does not apply to model aircraft flown indoors).
  - g. Not operate aircraft with metal-blade propellers or with gaseous boosts except for helicopters operated under the provisions of AMA Document #555.
  - h. Not operate model aircraft while under the influence of alcohol or while using any drug which could adversely affect the pilot's ability to safely control the model.
  - i. Not operate model aircraft carrying pyrotechnic devices which explode or burn, or any device which propels a projectile or drops any object that creates a hazard to persons or property.
 

Exceptions:

    - Free Flight fuses or devices that burn producing smoke and are securely attached to the model aircraft during flight.
    - Rocket motors (using solid propellant) up to a G-series size may be used provided they remain attached to the model during flight. Model rockets may be flown in accordance with the National Model Rocketry Safety Code but may not be launched from model aircraft.
    - Officially designated AMA Air Show Teams (AST) are authorized to use devices and practices as defined within the Team AMA Program Document (AMA Document #718).
  - j. Not operate a turbine-powered aircraft, unless in compliance with the AMA turbine regulations. (AMA Document #510-A).
11. Model aircraft will not be flown in AMA sanctioned events, air shows or model demonstrations unless:
  - l. The aircraft, control system and pilot skills have successfully demonstrated all maneuvers intended or anticipated prior to the specific event.
  - m. An inexperienced pilot is assisted by an experienced pilot.
4. When and where required by rule, helmets must be properly worn and fastened. They must be OSHA, DOT, ANSI, SNELL or NOCSAE approved or comply with comparable standards.

## B. RADIO CONTROL

1. All pilots shall avoid flying directly over unprotected people, vessels, vehicles or structures and shall avoid endangerment of life and property of others
2. A successful radio equipment ground-range check in accordance with manufacturer's recommendations will be completed before the first flight of a new or repaired model aircraft.
3. At all flying sites a safety line(s) must be established in front of which all flying takes place (AMA Document #706.)
  - a. Only personnel associated with flying the model aircraft are allowed at or in front of the safety line.
  - b. At air shows or demonstrations, a straight safety line must be established.
  - c. An area away from the safety line must be maintained for spectators.
  - d. Intentional flying behind the safety line is prohibited.
4. RC model aircraft must use the radio-control frequencies currently allowed by the Federal Communications Commission (FCC). Only individuals properly licensed by the FCC are authorized to operate equipment on Amateur Band frequencies.
5. RC model aircraft will not operate within three (3) miles of any pre-existing flying site without a frequency-management agreement (AMA Documents #922 and #923.)
6. With the exception of events flown under official AMA Competition Regulations, excluding takeoff and landing, no powered model may be flown outdoors closer than 25 feet to any individual, except for the pilot and the pilot's helper(s) located at the flight line.
7. Under no circumstances may a pilot or other person touch a model aircraft in flight while it is still under power, except to divert it from striking an individual.
8. RC night flying requires a lighting system providing the pilot with a clear view of the model's attitude and orientation at all times. Hand-held illumination systems are inadequate for night flying operations.
9. The pilot of a RC model aircraft shall:
  - a. Maintain control during the entire flight, maintaining visual contact without enhancement other than by corrective lenses prescribed for the pilot.
  - b. Fly using the assistance of a camera or First-Person View (FPV) only in accordance with the procedures outlined in AMA Document #550.
  - c. Fly using the assistance of autopilot or stabilization system only in accordance with the procedures outlined in AMA Document #560.

Please see your local or regional modeling association's guidelines for proper, safe operation of your model aircraft.

## Limited Warranty

### What this Warranty Covers

Horizon Hobby, LLC, (Horizon) warrants to the original purchaser that the product purchased (the "Product") will be free from defects in materials and workmanship at the date of purchase.

### What is Not Covered

This warranty is not transferable and does not cover (i) cosmetic damage, (ii) damage due to acts of God, accident, misuse, abuse, negligence, commercial use, or due to improper use, installation, operation or maintenance, (iii) modification of or to any part of the Product, (iv) attempted service by anyone other than a Horizon Hobby authorized service center, (v) Product not purchased from an authorized Horizon dealer, or (vi) Product not compliant with applicable technical regulations, or (vii) use that violates any applicable laws, rules, or regulations.

OTHER THAN THE EXPRESS WARRANTY ABOVE, HORIZON MAKES NO OTHER WARRANTY OR REPRESENTATION, AND HEREBY DISCLAIMS ANY AND ALL IMPLIED WARRANTIES, INCLUDING, WITHOUT LIMITATION, THE IMPLIED WARRANTIES OF NON-INFRINGEMENT, MERCHANTABILITY AND FITNESS FOR A PARTICULAR PURPOSE. THE PURCHASER ACKNOWLEDGES THAT THEY ALONE HAVE DETERMINED THAT THE PRODUCT WILL SUITABLY MEET THE REQUIREMENTS OF THE PURCHASER'S INTENDED USE.

### Purchaser's Remedy

Horizon's sole obligation and purchaser's sole and exclusive remedy shall be that Horizon will, at its option, either (i) service, or (ii) replace, any Product determined by Horizon to be defective. Horizon reserves the right to inspect any and all Product(s) involved in a warranty claim. Service or replacement decisions are at the sole discretion of Horizon. Proof of purchase is required for all warranty claims. SERVICE OR REPLACEMENT AS PROVIDED UNDER THIS WARRANTY IS THE PURCHASER'S SOLE AND EXCLUSIVE REMEDY.

### Limitation of Liability

HORIZON SHALL NOT BE LIABLE FOR SPECIAL, INDIRECT, INCIDENTAL OR CONSEQUENTIAL DAMAGES, LOSS OF PROFITS OR PRODUCTION OR COMMERCIAL LOSS IN ANY WAY, REGARDLESS OF WHETHER SUCH CLAIM IS BASED IN CONTRACT, WARRANTY, TORT, NEGLIGENCE, STRICT LIABILITY OR ANY OTHER THEORY OF LIABILITY, EVEN IF HORIZON HAS BEEN ADVISED OF THE POSSIBILITY OF SUCH DAMAGES. Further, in no event shall the liability of Horizon exceed the individual price of the Product on which liability is asserted. As Horizon has no control over use, setup, final assembly, modification or misuse, no liability shall be assumed nor accepted for any resulting damage or injury. By the act of use, setup or assembly, the user accepts all resulting liability. If you as the purchaser or user are not prepared to accept the liability associated with the use of the Product, purchaser is advised to return the Product immediately in new and unused condition to the place of purchase.

### Law

These terms are governed by Illinois law (without regard to conflict of law principals). This warranty gives you specific legal rights, and you may also have other rights which vary from state to state. Horizon reserves the right to change or modify this warranty at any time without notice.

### WARRANTY SERVICES

#### Questions, Assistance, and Services

Your local hobby store and/or place of purchase cannot provide warranty support or service. Once assembly, setup or use of the Product has been started, you must contact your local distributor or Horizon directly. This will enable Horizon to better answer your questions and service you in the event

that you may need any assistance. For questions or assistance, please visit our website at [www.horizonhobby.com](http://www.horizonhobby.com), submit a Product Support Inquiry, or call the toll free telephone number referenced in the Warranty and Service Contact Information section to speak with a Product Support representative.

### Inspection or Services

If this Product needs to be inspected or serviced and is compliant in the country you live and use the Product in, please use the Horizon Online Service Request submission process found on our website or call Horizon to obtain a Return Merchandise Authorization (RMA) number. Pack the Product securely using a shipping carton. Please note that original boxes may be included, but are not designed to withstand the rigors of shipping without additional protection. Ship via a carrier that provides tracking and insurance for lost or damaged parcels, as Horizon is not responsible for merchandise until it arrives and is accepted at our facility. An Online Service Request is available at [http://www.horizonhobby.com/content/\\_service-center\\_render-service-center](http://www.horizonhobby.com/content/_service-center_render-service-center). If you do not have internet access, please contact Horizon Product Support to obtain a RMA number along with instructions for submitting your product for service. When calling Horizon, you will be asked to provide your complete name, street address, email address and phone number where you can be reached during business hours. When sending product into Horizon, please include your RMA number, a list of the included items, and a brief summary of the problem. A copy of your original sales receipt must be included for warranty consideration. Be sure your name, address, and RMA number are clearly written on the outside of the shipping carton.

**NOTICE: Do not ship LiPo batteries to Horizon. If you have any issue with a LiPo battery, please contact the appropriate Horizon Product Support office.**

### Warranty Requirements

**For Warranty consideration, you must include your original sales receipt verifying the proof-of-purchase date.** Provided warranty conditions have been met, your Product will be serviced or replaced free of charge. Service or replacement decisions are at the sole discretion of Horizon.

### Non-Warranty Service

**Should your service not be covered by warranty, service will be completed and payment will be required without notification or estimate of the expense unless the expense exceeds 50% of the retail purchase cost.** By submitting the item for service you are agreeing to payment of the service without notification. Service estimates are available upon request. You must include this request with your item submitted for service. Non-warranty service estimates will be billed a minimum of ½ hour of labor. In addition you will be billed for return freight. Horizon accepts money orders and cashier's checks, as well as Visa, MasterCard, American Express, and Discover cards. By submitting any item to Horizon for service, you are agreeing to Horizon's Terms and Conditions found on our website [http://www.horizonhobby.com/content/\\_service-center\\_render-service-center](http://www.horizonhobby.com/content/_service-center_render-service-center).

**ATTENTION: Horizon service is limited to Product compliant in the country of use and ownership. If received, a non-compliant Product will not be serviced. Further, the sender will be responsible for arranging return shipment of the un-serviced Product, through a carrier of the sender's choice and at the sender's expense. Horizon will hold non-compliant Product for a period of 60 days from notification, after which it will be discarded.**

10/15

## Contact Information

Country of Purchase	Horizon Hobby	Contact Information	Address
United States of America	Horizon Service Center (Repairs and Repair Requests)	<a href="http://servicecenter.horizonhobby.com/RequestForm/">servicecenter.horizonhobby.com/RequestForm/</a>	4105 Fieldstone Rd Champaign, Illinois, 61822 USA
	Horizon Product Support (Product Technical Assistance)	<a href="mailto:productsupport@horizonhobby.com">productsupport@horizonhobby.com</a> 877-504-0233	
	Sales	<a href="mailto:websales@horizonhobby.com">websales@horizonhobby.com</a> 800-338-4639	
European Union	Horizon Technischer Service	<a href="mailto:service@horizonhobby.eu">service@horizonhobby.eu</a>	Hanskampring 9 D 22885 Barsbüttel, Germany
	Sales: Horizon Hobby GmbH	+49 (0) 4121 2655 100	

## FCC Information

### FCC ID: BRWSPMR4648A

This equipment has been tested and found to comply with the limits for Part 15 of the FCC rules. These limits are designed to provide reasonable protection against harmful interference in a residential installation. This equipment generates uses and can radiate radio frequency energy and, if not installed and used in accordance with the instructions, may cause harmful interference to radio communications.

However, there is no guarantee that interference will not occur in a particular installation. If this equipment does cause harmful interference to radio or television reception, which can be determined by turning the equipment off and on, the user is encouraged to try to correct the interference by one or more of the following measures:

- Reorient or relocate the receiving antenna.
- Increase the separation between the equipment and receiver.
- Connect the equipment to an outlet on a circuit different from that to which the receiver is connected.
- Consult the dealer or an experienced radio/TV technician for help.

This device complies with part 15 of the FCC rules. Operation is subject to the following two conditions: (1) This device may not cause harmful interference, and (2) this device must accept any interference received, including interference that may cause undesired operation.

**NOTICE:** Modifications to this product will void the user's authority to operate this equipment.

## IC Information

### IC: 6157A-SPMR4648A

This device complies with Industry Canada licence-exempt RSS standard(s). Operation is subject to the following two conditions: (1) this device may not cause interference, and (2) this device must accept any interference received, including interference that may cause undesired operation of the device."

## Compliance Information for the European Union



### Opterra 1.2m S+ BNF Basic (EFL11450) EU Compliance Statement:

Horizon Hobby, LLC hereby declares that this product is in compliance with the essential requirements and other relevant provisions of the RED and EMC Directives.

A copy of the EU Declaration of Conformity is available online at:

<http://www.horizonhobby.com/content/support-render-compliance>.

### Opterra 1.2m PNP (EFL11475)

#### EU Compliance Statement:

Horizon Hobby, LLC hereby declares that this product is in compliance with the essential requirements and other relevant provisions of the EMC Directive.

A copy of the EU Declaration of Conformity is available online at:

<http://www.horizonhobby.com/content/support-render-compliance>.



### Instructions for disposal of WEEE by users in the European Union

This product must not be disposed of with other waste. Instead, it is the user's responsibility to dispose of their waste equipment by handing it over to a designated collection point for the recycling of waste electrical and electronic equipment. The separate collection and recycling of your waste equipment at the time of disposal will help to conserve natural resources and make sure that it is recycled in a manner that protects human health and the environment. For more information about where you can drop off your waste equipment for recycling, please contact your local city office, your household waste disposal service or where you purchased the product.



The Opterra 1.2m S+ BNF with FPV (EFL11460) is not available in Europe

## Recommended Receivers • Empfohlene Empfänger Récepteurs Recommandés • Ricevitori Raccomandati

**PNP Only • Nur PNP • PNP Uniquement • Solo PNP**

Part #   Nummer Numéro   Codice	Description	Beschreibung	Description	Descrizione
SPMAR610	AR610 6-Channel Coated Air Receiver	Ummantelter AR610-6-Kanal-Flugzeugempfänger	Récepteur aérien avec revêtement 6 canaux AR610	Ricevente aereo AR610 6 canali con rivestimento
	<b>Telemetry Equipped Receivers</b>	<b>Empfänger mit Telemetrie</b>	<b>Récepteurs avec télémétrie</b>	<b>Riceventi con telemetria</b>
SPMAR6600T	AR6600T 6-Channel Air Integrated Telemetry Receiver	AR6600T-6-Kanal-Flugzeugempfänger mit integrierter Telemetrie	Récepteur aérien avec télémétrie intégrée 6 canaux AR6600T	Ricevente aereo AR6600T 6 canali con telemetria integrata
SPMAR6270T	AR6270T 6-Channel Carbon Fuse Integrated Telemetry Receiver	AR6270T-6-Kanal-Karbon-Sicherungempfänger mit integrierter Telemetrie	Récepteur à fusibles en carbone avec télémétrie intégrée 6 canaux AR6270T	Ricevente AR6270T 6 canali con telemetria integrata per fusoliera in carbonio
SPMAR8010T	AR8010T 8-Channel Air Integrated Telemetry Receiver	AR8010T-8-Kanal-Flugzeugempfänger mit integrierter Telemetrie	Récepteur aérien avec télémétrie intégrée 8 canaux AR8010T	Ricevente aereo AR8010T 8 canali con telemetria integrata
SPMAR9030T	AR9030T 9-Channel Air Integrated Telemetry Receiver	AR9030T-9-Kanal-Flugzeugempfänger mit integrierter Telemetrie	Récepteur aérien avec télémétrie intégrée 9 canaux AR9030T	Ricevente aereo AR9030T 9 canali con telemetria integrata
	<b>AS3X Equipped Receivers</b>	<b>AS3X-Empfänger</b>	<b>Récepteurs avec AS3X</b>	<b>Riceventi con AS3X</b>
SPMAR636	AR636 6-Channel AS3X Sport Receiver	AR636-6-Kanal-AS3X-Sportempfänger	Récepteur AS3X sport 6 canaux AR636	AR636 ricevitore sportivo a 6 canali AS3X
	<b>AS3X and Telemetry Equipped Receivers</b>	<b>AS3X- und Telemetrieempfänger</b>	<b>Récepteurs avec AS3X et télémétrie</b>	<b>Riceventi con AS3X e telemetria</b>
SPMAR7350	AR7350 7-Channel AS3X Receiver with Integrated Telemetry	AR7350-7-Kanal-Empfänger	Récepteur 7 canaux AR7350	Ricevente AR7350 7 canali
SPMAR9350	AR9350 7-Channel AS3X Receiver with Integrated Telemetry	AR9350-7-Kanal-Empfänger	Récepteur 7 canaux AR9350	Ricevente AR9350 7 canali
	<b>Telemetry Sensors*</b>	<b>Telemetriesensoren*</b>	<b>Capteurs télémétriques*</b>	<b>Sensori di telemetria*</b>
SPMA9574	Aircraft Telemetry Airspeed Indicator	Flugzeugtelemetrie-Luftgeschwindigkeitsanzeige	Indicateur télémétrique de vitesse aérodynamique pour avion	Telemetria per aerei - Anemometro
SPMA9589	Aircraft Telemetry Altitude and Variometer Sensor	Flugzeugtelemetrie-Höhen- und Variometer-Sensor	Indicateur télémétrique d'altitude et variomètre pour avion	Telemetria per aerei - Sensore altimetrico e variometro
SPMA9558	Brushless RPM Sensor	Bürstenloser Drehzahlsensor	Capteur de tr/min sans balai	Sensore RPM brushless
SPMA9605	Aircraft Telemetry Flight Pack Battery Energy Sensor	Flugzeugtelemetrie-Flugakkupack-Energiesensor	Capteur télémétrique de niveau de batterie de vol pour avion	Telemetria per aerei - Sensore per la misura dell'energia della batteria di bordo
SPMA9587	Aircraft Telemetry GPS Sensor	Flugzeugtelemetrie-GPS-Sensor	Capteur télémétrique GPS pour avion	Telemetria per aerei - Sensore GPS

\* Not compatible with BNF, Telemetry receiver required

\* Nicht kompatibel mit BNF, Telemetrieempfänger erforderlich

\* Non compatible avec les modèles BNF, récepteur télémétrique requis

\* Non compatibile con BNF, necessita di ricevente con telemetria



## Replacement Parts • Ersatzteile • Pièces de rechange • Pezzi di ricambio

Part #   Nummer Numéro   Codice	Description	Beschreibung	Description	Descrizione
BLH8611	BI Motor, Clockwise: Chroma	BI Motor, im Uhrzeigersinn: Chroma	Moteur BI, sens horaire: Chroma	BI Motor, senso orario: Chroma
EFL11401	Fuselage: 1.2M Opterra	Rumpf: 1.2M Opterra	Fuselage: 1.2M Opterra	Fusoliera: 1.2M Opterra
EFL11402	Wing Set: 1.2M Opterra	Flügelsatz: 1.2M Opterra	Jeu d'ailes: 1.2M Opterra	Set ala: 1.2M Opterra
EFL11403	Carbon Tube: 1.2M Opterra	Kohlenstoffröhre: 1.2M Opterra	Tube de carbone: 1.2M Opterra	Tubo di carbonio: Op. 1,2 m
EFL11404	Center Fin Set: 1.2M Opterra	Mittelflossensatz: 1.2M Opterra	Centre Fin Set: 1.2M Opterra	Set aletta centrale: 1.2M Opterra
EFL11405	Control Horn Set: 1.2M Opterra	Kontrollhornsatz: 1.2M Opterra	Set de cor de contrôle: 1.2M Opterra	Set di clacson di controllo: 1.2M Opterra
EFL11406	Nose Cone Set: 1.2M Opterra	Nasenkegel Set: 1.2M Opterra	Cône de nez Set: 1.2M Opterra	Set Cono Naso: 1.2M Opterra
EFL11407	Brushless Motor: 1.2M Opterra	Bürstenloser Motor: 1.2M Opterra	Moteur Brushless: 1.2M Opterra	Motore Brushless: 1.2M Opterra
EFL11408	Prop/ Spinner: 1.2 Opterra	Prop / Spinner: 1.2 Opterra	Hélice / Cône: 1.2 Opterra	Elica / Ogiva: 1.2 Opterra
EFL11409	Decal Sheet: 1.2M Opterra	Aufkleber: 1.2M Opterra	Feuille de décalque: 1.2M Opterra	Foglio decalcomania: 1.2M Opterra
EFLA1030B	30-Amp Pro SB Brushless ESC (V2)	30 Ampere Pro SB Brushless Regler (V2)	ESC brushless Pro SB 30 A (V2)	ESC senza spazzola 30-Amp Pro (V2)
EFLR7155	13g Digital Micro Servo	13g Digitaler Micro Servo	13g Micro Servo Numérique	13g Servocomando digitale
SPMA3235	Flight Controller	Flugsteuerung	Contrôleur de vol	Controllore di volo
SPMA3173	Spektrum GPS Module	Spektrum GPS-Modul	Spektrum Module GPS	Spektrum Modulo GPS
SPMVC602	600TVL CMOS FPV Camera	600TVL CMOS FPV Kamera	600TVL CMOS FPV Caméra	600TVL CMOS FPV Videocamera
SPMVT1001	25-200-600mW 5.8GHz VTX with OSD (North America Only)	NA	25-200-600mW 5.8GHz VTX avec OSD (Nord Amérique Seulement)	NA
SPMVT1001EU	25mW 5.8GHz VTX with OSD	25mW 5.8GHz VTX mit OSD	25mW 5.8GHz VTX avec OSD	25mW 5.8GHz VTX e OSD

## Optional Parts • Optionale Bauteile • Pièces optionnelles • Pezzi opzionali

Part #   Nummer Numéro   Codice	Description	Beschreibung	Description	Descrizione
EFLA250	Park Flyer Tool Assortment, 5 pc	Park Flyer Werkzeugsortiment, 5 teilig	Assortiment d'outils park flyer, 5pc	Park Flyer assortimento attrezzi, 5 pc
EFLAEC302	EC3 Battery Connector, Female (2)	EC3 Akkukabel, Buchse (2)	Prise EC3 femelle (2pc)	EC3 Connettore femmina x batteria (2)
EFLAEC303	EC3 Device/Battery Connector, Male/Female	EC3 Kabelsatz, Stecker/Buchse	Prise EC3 male/femelle	EC3 Connettore batteria maschio/femmina
EFLB22003S30	11.1V 3S 30C 2200MAH Li-Po	11.1V 3S 30C 2200mAh LiPo	Li-Po 3S 11,1V 2200mA 30C	11.1V 3S 30C 2200MAH Li-Po
EFLB25003S30	11.1V 3S 30C 2500MAH Li-Po	11.1V 3S 30C 2500mAh LiPo	Li-Po 3S 11,1V 2500mA 30C	11.1V 3S 30C 2500MAH Li-Po
EFLRB18004S35	14.8V 3S 35C 1800MAH Li-Po	14.8V 4S 35C 1800mAh LiPo	Li-Po 4S 14,8V 1800mA 30C	14.8V 4S 35C 1800MAH Li-Po
EFLB22004S30	14.8V 4S 30C 2200MAH Li-Po	14.8V 4S 30C 2200mAh LiPo	Li-Po 4S 14,8V 2200mA 30C	14.8V 4S 30C 2200MAH Li-Po
DYNC2030	Passport Sport Mini 50W Multi Chemistry Charger			
KXSC1004	KX50D Duo 2 x 50W AC/DC Charger	KX50D Duo 2 x 50 W Wechsel-/Gleichstrom-Ladegerät	Chargeur KX50D Duo 2 x 50W AS/DC	Caricabatteria AC/DC KX50D Duo 2 x 50 W
DYNC2010CA	Prophet Sport Plus 50W AC DC Charger	Dynamite Ladegerät Prophet Sport Plus 50W AC/DC EU	Chargeur Prophet Sport Plus 50W AC DC	Caricabatterie Prophet Sport Plus 50W AC DC
SPMA3081	AS3X Programming Cable - Audio Interface	Spektrum Audio-Interface AS3X Empfänger Programmierkabel	Câble de programmation audio AS3X pour smartphone	Cavo di programmazione AS3X - Interfaccia audio
SPMA3065	AS3X Programming Cable - USB Interface	Spektrum USB-Interface AS3X Empfänger Programmierkabel	Câble de programmation USB AS3X pour PC	Cavo di programmazione AS3X - Interfaccia USB
EFLA111	Li-Po Cell Voltage Checker	Li-Po Cell Voltage Checker	Testeur de tension d'éléments Li-Po	Voltmetro verifica batterie LiPo
DYN1405	Li-Po Charge Protection Bag, Large	Dynamite LiPoCharge Protection Bag groß	Sac de charge Li-Po, grand modèle	Sacchetto grande di protezione per carica LiPo
DYN1400	Li-Po Charge Protection Bag, Small	Dynamite LiPoCharge Protection Bag klein	Sac de charge Li-Po, petit modèle	Sacchetto piccolo di protezione per carica LiPo
	DXe DSMX 6-Channel Transmitter	Spektrum DXe DSMX 6-Kanal Sender	Emetteur DXe DSMX 6 voies	DXe DSMX Trasmettitore 6 canali
	DX6eDSMX 6-Channel Transmitter	Spektrum DX6e DSMX 6-Kanal Sender	Emetteur DX6e DSMX 6 voies	DX6e DSMX Trasmettitore 6 canali
	DX6 DSMX 6-Channel Transmitter	Spektrum DX6 DSMX 6-Kanal Sender	Emetteur DX6 DSMX 6 voies	DX6 DSMX Trasmettitore 6 canali
	DX8G2 DSMX 8-Channel Transmitter	Spektrum DX8G2 DSMX 8 Kanal Sender	Emetteur DX8G2 DSMX 8 voies	DX8G2 DSMX Trasmettitore 8 canali
	DX9 DSMX 9-Channel Transmitter	Spektrum DX9 DSMX 9 Kanal Sender	Emetteur DX9 DSMX 9 voies	DX9 DSMX Trasmettitore 9 canali
	DX18 DSMX 18-Channel Transmitter	Spektrum DX18 DSMX 18 Kanal Sender	Emetteur DX18 DSMX 18 voies	DX18 DSMX Trasmettitore 18 canali
	DX20 DSMX 20-Channel Transmitter	Spektrum DX 20 DSMX 20 Kanal Sender	Emetteur DX20 DSMX 20 voies	DX 20 DSMX Trasmettitore 20 canali
	iX12 DSMX 12-Channel Transmitter	Spektrum iX 12 DSMX 12 Kanal Sender	Emetteur iX12 DSMX 12 voies	iX 12 DSMX Trasmettitore 12 canali



© 2018 Horizon Hobby, LLC.

E-flite, Opterra, DSM, DSM2, DSMX, Bind-N-Fly, BNF, the BNF logo, Plug-N-Play, AS3X, SAFE, the SAFE logo, Passport, Prophet, EC3, and the Horizon Hobby logo are trademarks or registered trademarks of Horizon Hobby, LLC.

The Spektrum trademark is used with permission of Bachmann Industries, Inc.

All other trademarks, service marks and logos are property of their respective owners.

US 8,672,726. US 9,056,667. Other patents pending.

<http://www.e-fliterc.com/>