



SPEKTRUM®

**AR9140T, AR12310T, and AR20310T
PowerSafe™ User Guide**

**Bedienungsanleitung AR9140T, AR12310T und
AR20310T PowerSafe**

**Guide de l'utilisateur AR9140T, AR12310T et
AR20310T PowerSafe**

**Manuale utente AR9140T, AR12310T e
AR20310T PowerSafe**

NOTICE

All instructions, warranties and other collateral documents are subject to change at the sole discretion of Horizon Hobby, LLC. For up-to-date product literature, visit horizonhobby.com and click on the support tab for this product.

Meaning of Special Language

The following terms are used throughout the product literature to indicate various levels of potential harm when operating this product:

NOTICE: Procedures, which if not properly followed, create a possibility of physical property damage AND a little or no possibility of injury.

CAUTION: Procedures, which if not properly followed, create the probability of physical property damage AND a possibility of serious injury.

WARNING: Procedures, which if not properly followed, create the probability of property damage, collateral damage, and serious injury OR create a high probability of superficial injury.



WARNING: Read the ENTIRE instruction manual to become familiar with the features of the product before operating. Failure to operate the product correctly can result in damage to the product, personal property and cause serious injury.

This is a sophisticated hobby product. It must be operated with caution and common sense and requires some basic mechanical ability. Failure to operate this Product in a safe and responsible manner could result in injury or damage to the product or other property. This product is not intended for use by children without direct adult supervision. Do not attempt disassembly, use with incompatible components or augment product in any way without the approval of Horizon Hobby, LLC. This manual contains instructions for safety, operation and maintenance. It is essential to read and follow all the instructions and warnings in the manual, prior to assembly, setup or use, in order to operate correctly and avoid damage or serious injury.

Age Recommendation: Not for children under 14 years. This is not a toy.

WARNING AGAINST COUNTERFEIT PRODUCTS

Always purchase from a Horizon Hobby, LLC authorized dealer to ensure authentic high-quality Spektrum product. Horizon Hobby, LLC disclaims all support and warranty with regards, but not limited to, compatibility and performance of counterfeit products or products claiming compatibility with DSM or Spektrum technology.

NOTICE: This product is only intended for use with unmanned, hobby-grade, remote-controlled vehicles and aircraft. Horizon Hobby disclaims all liability outside of the intended purpose and will not provide warranty service related thereto.

WARRANTY REGISTRATION

Visit www.spektrumrc.com/registration today to register your product.

User Guide

The Spektrum™ AR9140T, AR12310T and AR20310T PowerSafe™ telemetry receivers offer the ultimate solution for powering high-current draw radio systems. In aircraft with multiple high-current draw servos (e.g. giant-scale aircraft, jets, etc.), the PowerSafe receivers can provide peak current of up to 50 amps and offers true dual battery redundancy and a fail-on soft switch for the ultimate in reliability. By locating up to three remote receivers throughout the aircraft, the RF link can be optimized in even the most demanding aircraft installations that have significant conductive materials like carbon, stainless steel bypass tubes, tuned exhausts, etc. For models high in carbon fiber content the SPM9646 DSMX® Carbon Fiber Remote Receiver is compatible with these PowerSafe receivers.

These telemetry receivers feature 4 integrated telemetry ports that are compatible with Spektrum telemetry capable transmitters.

NOTICE: The Spektrum PowerSafe telemetry receivers are not compatible with the Spektrum/JR/FUTABA DSM2 modules

For information on Spektrum Telemetry Sensors visit:
<http://www.spektrumrc.com>

Applications

- Giant-scale aircraft
- Jets with multiple high-current draw servos
- Scale aircraft with multiple high-current draw servos and accessories (e.g. lights, ESCs, air valves, etc.)
- Scale helicopters

Features

- Integrated full range telemetry
- True dual battery redundancy—each battery is isolated and if one fails/ shorts the other takes over.
- Utilizes up to three remote receivers for the ultimate RF link in even the most demanding applications.
- Up to 35 amps continuous and 50 amps peak current handling capability
- Fail-on soft switch in case the switch is damaged
- Two types of failsafe—SmartSafe™ (throttle only) and preset failsafe (all servos)
- QuickConnect™ technology—if a power interruption (brownout) occurs, the system reconnects in less than 1/2 second
- Flight Log compatible
- Heavy 13AWG dual battery leads with pre-wired E-flite® EC3™ connectors
- 2048 resolution
- Compatible with X-Plus™ modules (AR20310T has the X-Plus module built in)

IMPORTANT: The PowerSafe receiver has a power distribution center that provides up to 35-amps continuous and 50-amps peak current to power your system. The AR9140T, AR12310T and AR20310T PowerSafe receivers use up to three (1 minimum connected to operate) remotely mounted receivers that can be optimally placed in your aircraft providing the best possible RF link in the most demanding conditions.

IMPORTANT: Aircraft using this receiver should use AMA sanctioned flying fields and follow the AMA safety codes at <https://www.modelaircraft.org/files/105.pdf>

Specifications	AR9140T	AR12310T	AR20310T
Type	DSM2/DSMX PowerSafe Telemetry Receiver		
Dimensions (LxWxH)	55.12 x 55.94 x 17.73mm	55.12 x 55.94 x 17.73mm	64.31 x 61.03 x 16.29mm
Weight	48.19g	48.19g	59.5g
Antenna Length	(1) - 6", (1) - 7"		
Remote Receivers	Yes(2)-Included	Yes(3)-Included	Yes(3)-Included
Channels	9	12	20
Band	2.4GHz		
Voltage Range	3.5-10V		

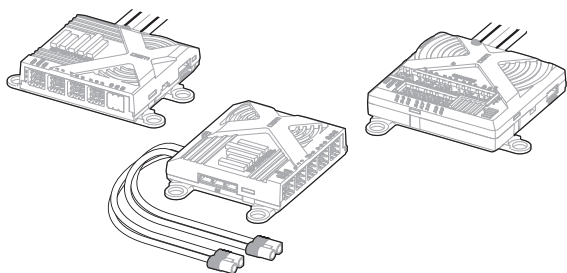

Included Items	AR9140T	AR12310T	AR20310T
SPM9645	(2) DSMX Remote Receiver	(3) DSMX Remote Receiver	(3) DSMX Remote Receiver
SPM9011	9" Remote Receiver Extension	9" Remote Receiver Extension	9" Remote Receiver Extension
SPM9012	12" Remote Receiver Extension	12" Remote Receiver Extension	12" Remote Receiver Extension
SPM9013	N/A	24" Remote Receiver Extension	24" Remote Receiver Extension
SPM6820	Soft switch	Soft switch	Soft switch
	Instruction Manual	Instruction Manual	Instruction Manual
EFLAEC302	(2) battery EC3 connectors	(2) battery EC3 connectors	(2) battery EC3 connectors
	(2) Charge receptacle	(2) Charge receptacle	(2) Charge receptacle
SPMA9570A	Aircraft Telemetry Volt Sensor	Aircraft Telemetry Volt Sensor	Aircraft Telemetry Volt Sensor

Battery Requirements

Using One Battery

The PowerSafe receiver allows the option of using one or two battery packs. When using one battery, simply plug the battery into either one of the two battery connectors (BATT 1 or BATT2). Be sure to secure the unused battery connector. Ensure that the open contacts of the unused battery are not back powered (not electrically hot), however, the unused connector should be secured to prevent it from entangling during flight. When the system is powered using one battery, a single blue LED will constantly emit when the system is powered on.

Using Two Batteries

The PowerSafe receiver offers a true redundant dual battery system. When using two battery packs, each pack functions independently and is isolated from the other so that if one pack should fail (open circuit, short-circuit, or become discharged) the other battery will provide power to operate the system. When using dual batteries, it's important that both batteries be of the same capacity and ideally of the same age and condition.

It's normal for one battery to discharge slightly more than the other. This is the nature of a truly redundant isolated battery system. The battery that has the higher voltage or lower internal resistance will discharge at a faster rate. Generally the difference is negligible (less than 10%). Because of this it's normal for only one blue LED (Batt 1 or Batt 2) to be on when the system is not under a heavy current load depending on which pack is providing more power.

When using two batteries, the total available capacity equals the sum total of both batteries e.g., BATT1 @ 2000mAh + BATT2 @ 2000mAh = a total capacity of 4000mAh. 12- and 24-inch EC3™ battery extensions (SPMEXEC312, SPMEXEC324) are available for installations where the battery is located a distance from the main PowerSafe unit.

Using Dual Voltage Regulators

The Spektrum™ 7.5 am (11-amp peak) 6.0 volt regulator (SPMVR6007) is specifically designed for use with the PowerSafe receivers.

IMPORTANT: When using two batteries powered through two regulators, each regulator operates independently and it's common for one battery to be discharged at a slightly higher rate depending on the condition of the battery (internal resistance, voltage, etc.) and the tolerance of the regulators. This causes one battery to discharge before the other and it's important to check each battery using a loaded battery tester (HAN171) at a recommended 1-amp load before each flight monitoring the voltage of each pack and recharging when the weakest pack reaches 40% capacity. (See Battery Capacity pg. 5)

Battery Capacity

It's important to select a battery(s) that has more than adequate capacity to provide the necessary flight time. Our staff has been recording in-flight data to determine typical current consumption of aircraft in flight. Following are two graphs that illustrate the in-flight current draw of the radio system. Current draws may vary depending on your servos, installation and flying style.

The following setup is shown as a worst-case scenario indicative of some aerobatic pilots' setups. It is not recommended to use this setup without proper voltage regulation for your servos.

Airplane	40% YAK
Servos	9-JR8711's 1-8317 (throttle)
Batteries	Two 4000mAh 2-cell 7.4-volt Li-Pos
Regulator	None
Engine	DA150
Weight	40 lb
Flight envelope	Aggressive 3D
Average current	2.62 amps
Peak current	17.8 amps
Milliamps (used per 10-minute flight)	435mAh

JR8711's and 8317's are rated at a maximum of 6-volt 5-cell use. Using higher voltages will void the warranty.

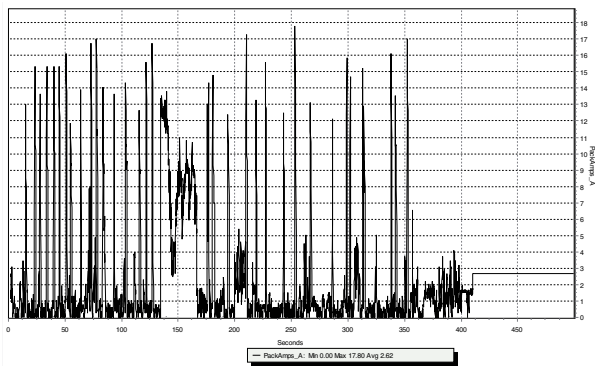

In the example above, the average current was 2.62 amps, which calculates to 435mAh per 10 minutes (typical flight length). It's recommended that only 60% of the available capacity be used to ensure plenty of reserve battery capacity. In this example, using two 4000mAh batteries (8000mAh total capacity) x 60%= 4800mAh (available usable capacity) divided by the capacity used per 10-minute flight. 435mAh would allow up to 11 flights of 10 minutes each.

Airplane	33% Sukhoi
Servos	7-JR8611's 1-8317 (throttle)
Batteries	1- 4000mAh 2-cell 7.4-volt LiPo
Regulator	6 volts
Engine	DA100
Weight	26 lb
Flight envelope	Moderate 3D
Average current	.82 amps
Peak current	6.92 amps
Milliamps (used per 10-minute flight)	137mAh

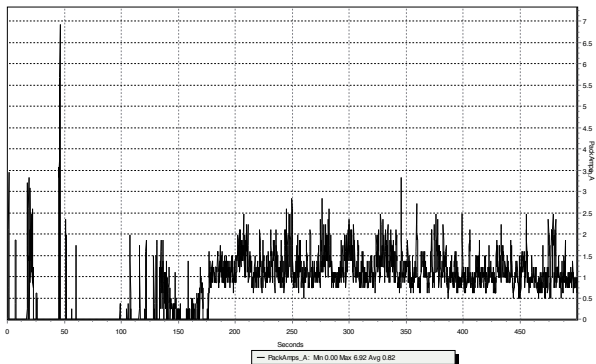

Recommended Guidelines for Battery Capacity

40-45% Aerobatic aircraft w/ 9-12 high-current servos: 4000–8000mAh

33-35% Aerobatic aircraft w/ 7-10 high-current servos: 3000–6000mAh

25% Quarter Scale Aerobatic aircraft w/ 5-7 high-current servos: 2000–4000mAh

Jets - BVM Super BANDIT, F86, Euro Sport, etc.: 3000–6000mAh

Giant-Scale Jets - BVM Ultra Bandit: 4000–8000mAh

Scale aircraft - The varieties of scale aircraft and the accessories they use vary tremendously, making it difficult to give capacity recommendations for these types of aircraft. Using the previously mentioned aerobatic guidelines relative to the size and number of servos used will provide a conservative capacity for your scale aircraft. As always, check battery charge condition before each flight.

Battery Voltage

IMPORTANT: DO NOT use a 4-cell 4.8-volt battery to power the PowerSafe receiver.

Four-cell 4.8-volt batteries do not provide enough voltage headroom (additional margin needed) necessary to power the system when heavily loaded. Under load the system voltage can drop below the voltage system's minimum operating voltage threshold (3.5 volts) and cause loss of control.

The PowerSafe receiver is capable of handling voltages from 6.0 to 10.0 volts. The voltage limitations are generally the servos. Most servos are compatible with 5-cell 6-volt packs. Five-cell 6-volt NiMH packs have become the standard for many giant-scale applications. There is no voltage regulation in the receiver. Voltage in = voltage out.

Be aware that NiMH batteries have a tendency to false peak when being fast charged. Be especially careful when using NiMH batteries that they are fully charged and have not false peaked.

Many pilots are using 2-cell LiPo batteries to power their aircraft. LiPo batteries offer greater capacity for their size and weight, and are easier to manage when charging. Before using LiPo batteries, please check the voltage specifications of your servos. Use of a voltage regulator, such as the Spektrum VR6007 (SP-MVR6007), might be necessary.

When a battery is connected to the PowerSafe receiver, a low current drain of less than 1mA occurs even when the switch is turned off. If the system is going to be stored for any length of time, it's important that the battery(s) be disconnected from the PowerSafe receiver to prevent over discharge.

Installation

The PowerSafe receiver requires a minimum of one remote receiver to operate. Two or three remote receivers are included and, in most cases, it is recommended that two or three receivers be used. Each receiver functions independently and additional receivers (up to three) offer a more secure RF link in difficult environments. The added security of redundancy should a failure occur will outweigh the slight additional penalties of cost and weight.

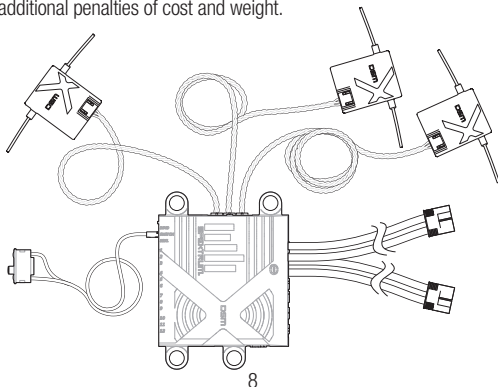

1. Using foam or thick double-sided foam tape and tie wraps, secure the main PowerSafe unit in the position where you would normally mount the receiver.
2. Mount the switch on the side of your aircraft and insert the switch plug in the port in the main unit marked SWITCH.

The PowerSafe receiver uses a specifically designed switch. Conventionally wired switches are not compatible with the PowerSafe receiver.

Installing Optional X-Plus 8 Module

When using an X-Plus™ receiver and module (Not required w/ the AR20310T - it's built into the receiver) it is recommended the X-Plus 8 module be mounted as close to the receiver as possible. When using the X-Plus power jumper lead mounting the X-Plus 8 module close will minimize the current loss from the receiver. Servo extensions can be use with each servo, it is recommended to use heavy 22 gauge wire with gold plated connectors.

If an auxiliary battery or batteries are to be used there is no need for the X-Plus power jumper. The X-Plus 8 module can be mounted further away from the receiver when using the auxiliary power option.

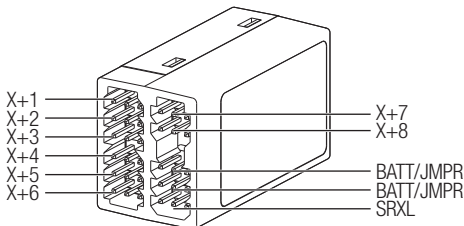

Installing the Batteries

Using the given guidelines select the battery system that best fits your application and install the battery(s)/regulator(s) in your aircraft. Connect the battery(s) to the PowerSafe receiver. Spektrum batteries are pre-wired with an EC3™ connector and plug directly in. If using another brand of battery it will be necessary to solder EC3 connectors (two are included with these PowerSafe receivers) to the battery leads. If using a regulator, install it per the guidelines included with the regulator.

Mounting the Remote Receivers

Antenna Polarization

For optimum RF link performance, it's important that the remote antennas be mounted in an orientation that allows for the best possible signal reception when the aircraft is at all possible attitudes and positions. This is known as antenna polarization. This allows the greatest exposed visual cross-section of the antennas from all aircraft orientations. Up to three Remote Receivers can be used, it is recommended that one remote be mounted vertically, one horizontally in-line with the fuselage and one horizontally perpendicular to the fuselage (see illustrations on pages 11-12). This covers the X,Y and Z axis offering superb cross-section visibility in all aircraft orientations.

Locating the Remote Receivers

While Spektrum 2.4GHz systems are far more resistant to interference caused from internal RF generating sources, the remote receivers should be mounted as far away as practical (typically 4" or greater if possible) from the following:

- Ignition systems
- Ignition switches
- ECU pumps
- Receiver batteries
- Metal bypass tubes
- High-vibration areas
- Ignition batteries
- Engines
- Electric motors
- Fuel tanks
- High-temperature components like exhaust systems
- Any significant metallic conductive components

The remote antennas should be mounted a minimum of at least 2" apart from each other as greater antenna separation gives improved path diversity (RF link performance) in critical environments. In large aircraft where space is not an issue, it is highly recommended that the antennas be mounted throughout the aircraft as illustrated. Spektrum remote receiver extensions range from 6" to 36" allowing the receivers to be mounted in the most optimum locations throughout the aircraft. Do not extend remote receivers greater than 36" from the main receiver.

Using double-sided foam tape and tie wraps, mount the remote receivers in your aircraft as per the illustrations and plug them into the receiver ports.

The following are illustrations of typically recommended installations. Note the remote receiver orientation.

- 35% aerobatic plane with single NiMH battery and three remote receivers

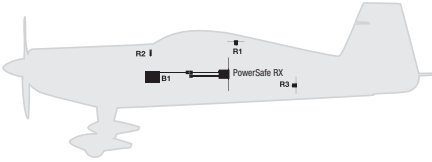

- 35% aerobatic plane with dual NiMH batteries and three remote receivers

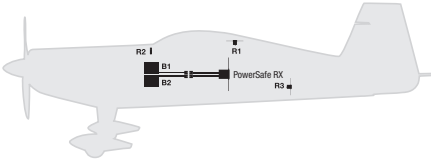

- 40% aerobatic plane with dual LiPo batteries, dual regulators and three remote receivers

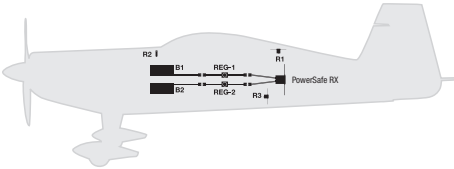

- Jet with dual LiPo batteries, dual regulators and three remote receivers

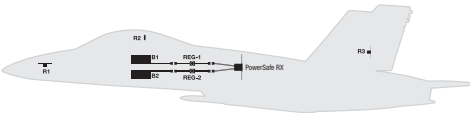

Binding

NOTICE: In order for the system to operate, one remote receiver must be connected. If an additional remote receiver is added after initial binding, the system must be re-bound to recognize the additional remote receiver.

How To Bind the PowerSafe Receiver

The AR9140T, AR12310T and AR20310T PowerSafe receivers must be bound to the transmitter before they will operate. Binding is the process of teaching the receiver the specific code of the transmitter so it will only connect to that specific transmitter.

1. Connect the remote receivers and any telemetry sensors to the main receiver.
2. Push and hold the bind button on the PowerSafe receiver while turning on the soft switch. Release the Bind button once all the LEDs on the receiver and remote receivers start to flash continuously.

Tip: It is still possible to use a bind plug in the BIND port if desired.

3. Put your transmitter in bind mode.
4. The bind process is complete when all the orange LEDs are solid.

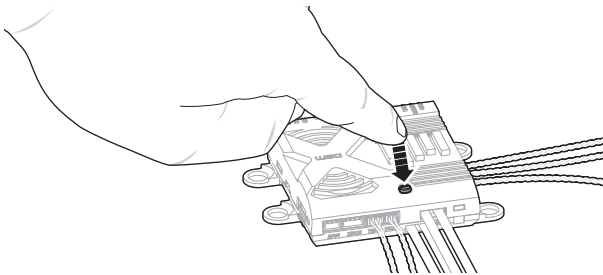

NOTICE: If using a bind plug, remove the bind plug after binding to prevent the system from entering bind mode the next time the power is turned on.

5. After you set up your model, always rebind the transmitter and receiver to set the desired failsafe positions. See FAILSAFE on the next page.

Failsafe

The AR9140T, AR12310T and AR20310T PowerSafe receivers features two types of failsafe: SmartSafe™ and Preset Failsafe.

Failsafe position is set during binding. In the unlikely event that the radio link is lost during use, the receiver will drive all channels to its pre-programmed failsafe position.

Pre-Connect Failsafe - Receiver Power Only

If the receiver is powered on, but there is no transmitter signal present (transmitter powered off), there will be no output pulses to the servos. The receiver remains in standby mode with the blue battery LEDs lit. When the transmitter is turned on, the receiver locates the signal (GUID), connects and normal control resumes. When connected, the amber LEDs on all attached remote receivers will be on.

After Connection

When the transmitter and receiver are turned on and after the receiver connects to the transmitter and normal control of all channels occurs, if loss of signal occurs Preset Failsafe drives all servos to their preset failsafe positions. For

SmartSafe + Hold Last

If loss of signal occurs, SmartSafe™ technology moves the throttle channel to its preset failsafe position (low throttle) that was set during binding. All other channels hold their last position. When the receiver detects a signal from the transmitter, normal aircraft operation resumes.

Tip: Use either the built in BIND button OR a bind plug in the BIND/BATT port.

SmartSafe + Hold Last

1	Lower Throttle on transmitter
2	Push and Hold Bind Button
3	Power on Receiver
4	Release Button once RX goes into Bind Mode (flashing LED)
5	Place transmitter in Bind Mode and finish Binding.

A*	<i>Install bind plug (optional)</i>
B*	<i>Leave in through entire bind process*</i>

*Setting Failsafe can be done with the Bind Plug if desired.

**Remove Bind Plug when finished setting up Failsafe.

Preset Failsafe

Preset failsafe is ideal for sailplanes, allowing the aircraft to automatically dethermalize if the signal is lost. With preset failsafe, all channels go to their preset failsafe positions if the signal is lost, preventing a flyaway. When the receiver detects a signal from the transmitter, normal aircraft operation resumes.

Preset Failsafe

1	Move all sticks and switches on the transmitter to desired Failsafe position.
2	Push and Hold Bind Button
3	Power on Receiver
4	Release Button after RX goes into Bind Mode (flashing LED)
5	Push and Hold the Bind Button again before the transmitter enters Bind Mode.
A*	<i>Install bind plug (optional)</i>
B*	<i>Remove plug once RX goes into Bind Mode</i>

*Setting Failsafe can be done with the Bind Plug if desired.

**Remove Bind Plug when finished setting up Failsafe.

sailplanes it's recommended that the spoilers/flaps deploy to dethermalize the aircraft, preventing a flyaway. Some modelers prefer to use this failsafe system to program a slight turn and low throttle to prevent their aircraft from flying away. When the signal is regained, the system immediately (less than 4 ms) regains control.

Range Testing

Before each flying session, and especially with a new model, it's important to

perform a range check. All Spektrum aircraft transmitters incorporate a range testing system, which reduces the output power to allow a range check.

1. With the model resting on the ground, stand 30 paces (approx. 90 feet/28 meters) away from the model.
2. Face the model with the transmitter in your normal flying position and put your transmitter into range test mode. This causes reduced power output from the transmitter.
3. You should have total control of the model in range test mode at 30 paces (90 feet/28 meters).
4. If control issues exist, call Horizon Product Support for further assistance.

Advanced Range Testing

The Standard Range Testing procedure is recommended for most sport aircraft. For sophisticated aircraft that contain significant amounts of conductive materials (e.g. turbine powered jets, some types of scale aircraft, aircraft with carbon fuselages, etc.), the following advanced range check will confirm that all remote receivers are operating optimally and that the installation (position of the receivers) is optimized for the specific aircraft. This Advanced Range Check allows the RF performance of each remote receiver to be evaluated and to optimize the locations of each individual remote receiver.

IMPORTANT: If you don't have a telemetry-capable transmitter, you can connect a Flight Log to the Bind/Prog port on the receiver.

1. Standing 30 paces away from the model, face the model with the transmitter in your normal flying position.
2. Put your transmitter in range test mode. Range test mode reduces the power output from the transmitter.
3. Have someone position the model in various orientations (nose up, nose down, nose toward the transmitter, nose away from the transmitter, etc.).
4. Observe the telemetry on your transmitter. Note any orientations that cause higher fade or hold values. Perform this step for at least one minute.
5. Re-position any remote receivers as necessary.
6. Have your helper position the model in various orientations (nose up, nose down, nose toward the Tx, nose away from the Tx, etc.) observe the telemetry on your transmitter or while your helper watches the Flight Log noting any correlation between the aircraft's orientation and frame losses. Do this for 1 minute. The timer on the transmitter can be used here. For giant-scale aircraft, it's recommended that the airplane be tipped up on its nose and rotated 360 degrees for one minute then the data recorded. Next place the airplane on its wheels and do a second test, rotating the aircraft in all directions for one minute.
7. After one minute, a successful range check will have less than ten recorded frame losses. Scrolling the Flight Log through the antenna fades (A, B, L, R) allows you to evaluate the performance of each receiver. Antenna

fades should be relatively uniform. If a specific antenna is experiencing a high degree of fades then that antenna should be moved to a different location.

8. A successful advanced test will yield the following:

H - 0 holds

F - less than 10 frame losses

A, B, R, L - Fades will typically be less than 100. It's important to compare the relative frame losses. If a particular receiver has a significantly higher frame loss value (2 to 3X) then the test should be redone. If the same results occur, move the offending receiver to a different location.

Flight Log

If you do not have a telemetry capable Spektrum transmitter, the Spektrum Flight Log (SPM9540) is also compatible with the AR9140T, AR12310T and AR20310T PowerSafe receivers.

The Flight Log displays overall RF link performance as well as the individual internal and external receiver link data. Additionally it displays receiver voltage.

Using the Flight Log

After a flight and before turning off the receiver or transmitter, plug the Flight Log into the Data port on the PowerSafe. The screen will automatically display voltage e.g. 6v2= 6.2 volts.

When the voltage reaches 4.8 volts or less, the screen will flash indicating low voltage.

Press the button to display the following information:

A - Antenna fades on antenna A

B - Antenna fades on antenna B

L - Antenna fades on the left antenna

R - Antenna fades on the right antenna

F - Frame loss

H - Holds

Antenna fades

Represents the loss of a bit of information on that specific antenna. Typically it's normal to have as many as 50 to 100 antenna fades during a flight. If any single antenna experiences over 500 fades in a single flight, the antenna should be repositioned in the aircraft to optimize the RF link.

Frame loss

represents simultaneous antenna fades on all attached receivers. If the RF link is

Receiver Power System Requirements

Inadequate power systems that are unable to provide the necessary minimum voltage to the receiver during flight have become the number one cause of in-flight failures. Some of the power system components that affect the ability to properly deliver adequate power include:

- Receiver battery pack (number of cells, capacity, cell type, state of charge)
- The ESC's capability to deliver current to the receiver in electric aircraft
- The switch harness, battery leads, servo leads, regulators etc.

The AR9140T/AR12310T/AR20310T have a minimum operational voltage of 3.5 volts; it is highly recommended the power system be tested per the guidelines below.

Power System Test Guidelines

If a questionable power system is being used (e.g. small or old battery, ESC that may not have a BEC that will support high-current draw, etc.), it is recommended that a voltmeter be used to perform the following tests.

The Hangar 9® Digital Servo & Rx Current Meter (HAN172) or the Spektrum Flight Log (SPM9540) is the perfect tool to perform the test below.

Plug the voltmeter into an open channel port in the receiver and with the system on, or simply monitor the voltage on a telemetry capable transmitter, load the control surfaces (apply pressure with your hand) while monitoring the voltage at the receiver. The voltage should remain above 4.8 volts even when all servos are heavily loaded.

How QuickConnect™ Technology Works

- When the receiver voltage drops below 3.5 volts the system ceases to operate.
- When power is restored the receiver immediately attempts to reconnect.
- If the transmitter was left on, the system reconnects typically in about 4/100 of a second.

NOTICE: If a brownout occurs in flight it is vital that the cause of the brownout be determined and corrected.

Important: Y-Harnesses and Servo Extensions

When using a Y-harness or servo extensions in your installation, it's important to use standard non-amplified Y-harnesses and servo extensions as this can/ will cause the servos to operate erratically or not function at all. Amplified Y-harnesses were developed several years ago to boost the signal for some older PCM systems and should not be used with Spektrum equipment. Note that when converting an existing model to Spektrum be certain that all amplified Y-harnesses and/or servo extensions are replaced with conventional non-amplified versions.

performing optimally, frame losses per flight should be less than 20. The antenna fades that caused the frame loss are recorded and will be added to the total antenna fades.

A Hold occurs when 45 consecutive frame losses occur. This takes about one second. If a hold occurs during a flight, it's important to re-evaluate the system, moving the antennas to different locations and/or checking to be sure the transmitter and receivers are all working correctly. The frame losses that led to the hold are not added to the total frame losses.

A servo extension can be used to allow the Flight Log to more conveniently be plugged in without having to remove the aircraft's hatch or canopy. On some models, the Flight Log can be plugged in, attached and left on the model using double-sided tape. This is common with helicopters, mounting the Flight Log conveniently to the side frame.

Telemetry

The Spektrum AR9140T, AR12310T and AR20310T PowerSafe telemetry receivers features 4 integrated telemetry ports that are compatible with Spektrum telemetry capable transmitters.

- No telemetry module required. Telemetry is built into the receiver.
- No sensor is required to receive Flight Log or receiver pack voltage directly on any telemetry capable Spektrum transmitter.
- The PowerSafe telemetry receivers include the SPMA9570 Aircraft Telemetry Flight Pack Voltage Sensor.
 1. Plug the Aircraft Telemetry Flight Pack Voltage Sensor into the VOLT Telemetry Port on the PowerSafe Receivers.
 2. Splice the other end into the flight battery pack noting polarity.

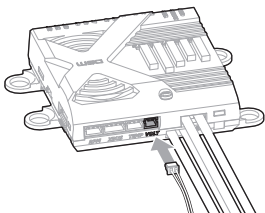

For information on Spektrum Telemetry Sensors visit:
<http://www.spektrumrc.com>

ModelMatch™ Technology

Some Spektrum and JR transmitters offer a patent pending feature called ModelMatch. ModelMatch technology prevents the possibility of operating a model using the wrong model memory, potentially preventing a crash. With ModelMatch, each model memory has its own unique code (GUID) and during the binding process the code is programmed into the receiver. Later, when the system is turned on, the receiver will only connect to the transmitter if the corresponding model memory is programmed on screen.

If at any time you turn on the system and it fails to connect, check to be sure the correct model memory is selected in the transmitter. Please note that the DX5e and Aircraft Modules do not have ModelMatch technology.

Frequently Asked Questions on Spektrum 2.4GHz

1. Q: After I've bound the receiver to my transmitter, which do I turn on first when I want to fly?

A: Either one. Every DSM 2.4GHz transmitter has a GUID (Globally Unique Identifier) code imbedded in its signal. When you bind a DSM receiver to your transmitter, this GUID code is stored in the receiver. If you turn the receiver on before the transmitter, you don't have to worry about it responding to another transmitter. The receiver will go into failsafe mode while it waits for a signal from the transmitter with the same GUID code it has stored. See the Receiver Power Only section for more information. If a DSM transmitter is turned on first you can expect it to connect within 6 seconds of powering on the receiver.

2. Q: Sometimes the system takes longer to connect or doesn't connect at all. Why?

A: In order for a DSM system to connect, the receiver must receive a large number of uninterrupted signal packets from the transmitter. This process takes just a few seconds, but if the transmitter is too close to the receiver (within 4 feet) or near reflective material (metal objects, carbon fiber material, etc.) it may detect its own reflected 2.4GHz energy as "noise". This can delay or prevent connection. If this happens, make sure you are a sufficient distance from metal objects and the receiver itself before you power up and try again.

3. Q: How important is Flight Log information?

A: All 2.4GHz signals, not just DSM, are affected by proximity to conductive materials such as carbon fiber or metal. If you are flying a model that uses a lot of conductive materials in its construction, Flight Log information can be helpful. The information collected when you fly can help determine the optimum location for your receiver(s) so you can minimize the effects of these materials on your signal performance.

1-Year Limited Warranty

What this Warranty Covers - Horizon Hobby, LLC, (Horizon) warrants to the original purchaser that the product purchased (the "Product") will be free from defects in materials and workmanship for a period of 1 year from the date of purchase.

What is Not Covered

This warranty is not transferable and does not cover (i) cosmetic damage, (ii) damage due to acts of God, accident, misuse, abuse, negligence, commercial use, or due to improper use, installation, operation or maintenance, (iii) modification of or to any part of the Product, (iv) attempted service by anyone other than a Horizon Hobby authorized service center, (v) Product not purchased from an authorized Horizon dealer, (vi) Product not compliant with applicable technical regulations, or (vii) use that violates any applicable laws, rules, or regulations.

OTHER THAN THE EXPRESS WARRANTY ABOVE, HORIZON MAKES NO OTHER WARRANTY OR REPRESENTATION, AND HEREBY DISCLAIMS ANY AND ALL IMPLIED WARRANTIES, INCLUDING, WITHOUT LIMITATION, THE IMPLIED WARRANTIES OF NON-INFRINGEMENT, MERCHANTABILITY AND FITNESS FOR A PARTICULAR PURPOSE. THE PURCHASER ACKNOWLEDGES THAT THEY ALONE HAVE DETERMINED THAT THE PRODUCT WILL SUITABLY MEET THE REQUIREMENTS OF THE PURCHASER'S INTENDED USE.

Purchaser's Remedy

Horizon's sole obligation and purchaser's sole and exclusive remedy shall be that Horizon will, at its option, either (i) service, or (ii) replace, any Product determined by Horizon to be defective. Horizon reserves the right to inspect any and all Product(s) involved in a warranty claim. Service or replacement decisions are at the sole discretion of Horizon. Proof of purchase is required for all warranty claims. SERVICE OR REPLACEMENT AS PROVIDED UNDER THIS WARRANTY IS THE PURCHASER'S SOLE AND EXCLUSIVE REMEDY.

Limitation of Liability

HORIZON SHALL NOT BE LIABLE FOR SPECIAL, INDIRECT, INCIDENTAL OR CONSEQUENTIAL DAMAGES, LOSS OF PROFITS OR PRODUCTION OR COMMERCIAL LOSS IN ANY WAY, REGARDLESS OF WHETHER SUCH CLAIM IS BASED IN CONTRACT, WARRANTY, TORT, NEGLIGENCE, STRICT LIABILITY OR ANY OTHER THEORY OF LIABILITY, EVEN IF HORIZON HAS BEEN ADVISED OF THE POSSIBILITY OF SUCH DAMAGES. Further, in no event shall the liability of Horizon exceed the individual price of the Product on which liability is asserted. As Horizon has no control over use, setup, final assembly, modification or misuse, no liability shall be assumed nor accepted for any resulting damage or injury. By the act of use, setup or assembly, the user accepts all resulting liability. If you as the purchaser or user are not prepared to accept the liability associated with the use of the Product, purchaser is advised to return the Product immediately in new and unused condition to the place of purchase.

Law

These terms are governed by Illinois law (without regard to conflict of law principals). This warranty gives you specific legal rights, and you may also have other rights which vary from state to state. Horizon reserves the right to change or modify this warranty at any time without notice.

WARRANTY SERVICES

Questions, Assistance, and Services

Your local hobby store and/or place of purchase cannot provide warranty support or service. Once assembly, setup or use of the Product has been started, you must contact your local distributor or Horizon directly. This will enable Horizon to better answer your questions and service you in the event that you may

need any assistance. For questions or assistance, please visit our website at www.horizonhobby.com, submit a Product Support Inquiry, or call the toll free telephone number referenced in the Warranty and Service Contact Information section to speak with a Product Support representative.

Inspection or Services

If this Product needs to be inspected or serviced and is compliant in the country you live and use the Product in, please use the Horizon Online Service Request submission process found on our website or call Horizon to obtain a Return Merchandise Authorization (RMA) number. Pack the Product securely using a shipping carton. Please note that original boxes may be included, but are not designed to withstand the rigors of shipping without additional protection. Ship via a carrier that provides tracking and insurance for lost or damaged parcels, as Horizon is not responsible for merchandise until it arrives and is accepted at our facility. An Online Service Request is available at http://www.horizonhobby.com/content/service-center_render-service-center. If you do not have internet access, please contact Horizon Product Support to obtain a RMA number along with instructions for submitting your product for service. When calling Horizon, you will be asked to provide your complete name, street address, email address and phone number where you can be reached during business hours. When sending product into Horizon, please include your RMA number, a list of the included items, and a brief summary of the problem. A copy of your original sales receipt must be included for warranty consideration. Be sure your name, address, and RMA number are clearly written on the outside of the shipping carton.

NOTICE: Do not ship LiPo batteries to Horizon. If you have any issue with a LiPo battery, please contact the appropriate Horizon Product Support office.

Warranty Requirements

For Warranty consideration, you must include your original sales receipt verifying the proof-of-purchase date. Provided warranty conditions have been met, your Product will be serviced or replaced free of charge. Service or replacement decisions are at the sole discretion of Horizon.

Non-Warranty Service

Should your service not be covered by warranty, service will be completed and payment will be required without notification or estimate of the expense unless the expense exceeds 50% of the retail purchase cost. By submitting the item for service you are agreeing to payment of the service without notification. Service estimates are available upon request. You must include this request with your item submitted for service. Non-warranty service estimates will be billed a minimum of ½ hour of labor. In addition you will be billed for return freight. Horizon accepts money orders and cashier's checks, as well as Visa, MasterCard, American Express, and Discover cards. By submitting any item to Horizon for service, you are agreeing to Horizon's Terms and Conditions found on our website http://www.horizonhobby.com/content/service-center_render-service-center.

ATTENTION: Horizon service is limited to Product compliant in the country of use and ownership. If received, a non-compliant Product will not be serviced. Further, the sender will be responsible for arranging return shipment of the un-serviced Product, through a carrier of the sender's choice and at the sender's expense. Horizon will hold non-compliant Product for a period of 60 days from notification, after which it will be discarded.

Warranty and Service Contact Information

Country of Purchase	Horizon Hobby	Contact Information	Address
United States of America	Horizon Service Center (Repairs and Repair Requests)	servicecenter.horizonhobby.com/RequestForm/	4105 Fieldstone Rd Champaign, Illinois, 61822 USA
	Horizon Product Support (Product Technical Assistance)	productsupport@horizonhobby.com.	
		877-504-0233	
Sales	websales@horizonhobby.com 800-338-4639		
EU	Horizon Technischer Service	service@horizonhobby.eu	Hanskampring 9 D 22885 Barsbüttel, Germany
	Sales: Horizon Hobby GmbH	+49 (0) 4121 2655 100	

FCC Information— FCC ID: BRWAR9140T • FCC ID: BRWAR20310T

This equipment has been tested and found to comply with the limits for a Class B digital device, pursuant to part 15 of the FCC Rules. These limits are designed to provide reasonable protection against harmful interference in a residential installation. This equipment generates, uses and can radiate radio frequency energy and, if not installed and used in accordance with the instructions, may cause harmful interference to radio communications.

However, there is no guarantee that interference will not occur in a particular installation. If this equipment does cause harmful interference to radio or television reception, which can be determined by turning the equipment off and on, the user is encouraged to try to correct the interference by one or more of the following measures:

Reorient or relocate the receiving antenna.

Increase the separation between the equipment and receiver.

Connect the equipment to an outlet on a circuit different from that to which the receiver is connected.

This device complies with part 15 of the FCC rules. Operation is subject to the following two conditions: (1) This device may not cause harmful interference, and (2) this device must accept any interference received, including interference that may cause undesired operation.

NOTICE: Modifications to this product will void the user's authority to operate this equipment.

This product contains a radio transmitter with wireless technology which has been tested and found to be compliant with the applicable regulations governing a radio transmitter in the 2.400GHz to 2.4835GHz frequency range.

IC Information– IC ID: 6157A-AR9140T • IC ID: 6157A-AR20310T

This device complies with Industry Canada license-exempt RSS standard(s). Operation is subject to the following two conditions: (1) this device may not cause interference, and (2) this device must accept any interference, including interference that may cause undesired operation of the device.

Compliance Information for the European Union

CE Horizon Hobby, LLC hereby declares that this product is in compliance with the essential requirements and other relevant provisions of the RED Directive.

A copy of the EU Declaration of Conformity is available online at:
<http://www.horizonhobby.com/content/support-render-compliance>.



Instructions for Disposal of WEEE by Users in the European Union

This product must not be disposed of with other waste. Instead, it is the user's responsibility to dispose of their waste equipment by handing it over to a designated collection point for the recycling of waste electrical and electronic equipment. The separate collection and recycling of your waste equipment at the time of disposal will help to conserve natural resources and ensure that it is recycled in a manner that protects human health and the environment. For more information about where you can drop off your waste equipment for recycling, please contact your local city office, your household waste disposal service or where you purchased the product.



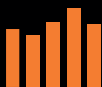

SPEKTRUM®

© 2017 Horizon Hobby, LLC.

DSM, DSM2, DSMX, QuickConnect, ModelMatch, SmartSafe, PowerSafe, EC3, X-Plus, E-flite, Hangar 9 and the Horizon Hobby logo are trademarks or registered trademarks of Horizon Hobby, LLC.

The Spektrum trademark is used with permission of Bachmann Industries, Inc.

JR is a registered trademark of JR Americas. All other trademarks, service marks and logos are property of their respective owners.

US 7,391,320. Other patents pending.

Created 03/17

52883.1

AR9140T / AR12310T / AR20310T