A black silhouette of a mountain range with several peaks of varying heights, located on the left side of the page and extending towards the bottom.

# MOUNTAIN VALLEY SCENERY KIT

S928

**INSTRUCTION BOOKLET**

# TABLE OF CONTENTS

<b>THE MOUNTAIN VALLEY SCENERY KIT</b>	<b>4</b>
<b>THE MOUNTAIN VALLEY SCENERY KIT CONTENTS</b>	<b>5</b>
<b>LAYOUT OVERVIEW</b>	<b>6</b>

## BEGIN YOUR LAYOUT

<b>PRIME THE BASE</b>	<b>8</b>
-----------------------	----------

<b>I. INSTALL RAILS AND ROADS</b>	<b>8</b>
-----------------------------------	----------

1. Lay Roadbed and Track: .....	8
2. Plan and Lay Streets and Roads: .....	10
3. Ballast the Track: .....	11

## TERRAIN

<b>II. CONSTRUCT TERRAIN SUBSTRUCTURE</b>	<b>12</b>
---	-----------

1. Trace and Cut Our Terrain Profiles: .....	12
2. Attach Mountain Profiles to Base: .....	13
3. Attach Tunnel and Access Support to Base: .....	15
4. Attach Tunnel Entrances: .....	16

<b>III. BUILD THE MOUNTAIN SHAPES</b>	<b>16</b>
---------------------------------------	-----------

1. Newspaper Wads: .....	16
2. Plaster Cloth .....	18

<b>IV. MAKE &amp; INSTALL ROCK CASTINGS</b>	<b>20</b>
---	-----------

1. Make Rock Castings: .....	20
2. Install Rock Castings: .....	21
3. Color Rock Castings: .....	22

## LANDSCAPE

<b>V. ADD LOW GROUND COVER</b>	<b>24</b>
--------------------------------	-----------

1. Color the Base and Sprinkle Turf: .....	24
2. Blend Turf Colors: .....	26

<b>VI. ADD MEDIUM GROUND COVER</b>	<b>27</b>
------------------------------------	-----------

1. Add Talus (Rock Debris) .....	27
2. Spread Poly Fiber and Apply Coarse Turf: .....	28

<b>VII. ADD HIGH GROUND COVER</b>	<b>30</b>
-----------------------------------	-----------

1. Assemble and Install Trees: .....	30
2. Clump-Foliage: .....	31
3. Field Grass: .....	32

## FINISHING TOUCHES

<b>VIII. DETAILING</b>	<b>33</b>
------------------------	-----------

1. Making It Match - Staining Talus (rock debris): .....	33
2. Add Additional Landscape Materials: .....	33
3. Dry Brushing: .....	33
4. Flyspecking with Turf: .....	34
5. Blend Your Structures into Scene: .....	34

<b>IX. FIX UP, CLEAN UP, START UP TIME</b>	<b>35</b>
1. Paint the Edges:.....	35
2. Remove Masks:.....	35
3. Clean Track:.....	35
<b>A FINAL WORD</b>	<b>36</b>
<b>GLOSSARY</b>	<b>37</b>
<b>PRODUCT NUMBER AND DESCRIPTION</b>	<b>39</b>
<b>TRACK REQUIREMENTS</b>	<b>40</b>

# THE MOUNTAIN VALLEY SCENERY KIT

## MOUNTAIN VALLEY, U.S.A. - WHERE TRAIN SETS BECOME MODEL RAILROADS.

We feel confident you will be happy with the layout you are about to build. This kit includes the patterns, materials and instructions you need to add terrain and landscaping to a 4' x 8' layout or any configuration totaling about 32 square feet.

In the process of constructing your layout, you will learn about Woodland Scenics SubTerrain, Terrain and Landscape Systems. Model railroading is a lifelong hobby so the methods you learn and the products you become familiar with will be of value to you on all future terrain and landscape modeling projects.

Read through the instructions in each section before beginning that section. Please note that all of the instructions in this booklet pertain to the layout you see in the model shown. If you wish to modify this layout, it is still a good idea to read through the instructions first. The first mention of a word that may be new to you or may be used in a different way is italicized and is defined in a Glossary at the end of this booklet.

Identify the contents of the box as listed on the next page. Make sure you also have the additional items required for construction and then begin building.

For further help in creating realistic terrain and landscape, Woodland Scenics has two excellent videos, *The Clinic (R990)*, which is a step-by-step demonstration of the methods and materials used to create a realistic layout, and *Model Scenery Made Easy (R993)*. Also available from Woodland Scenics is *The Scenery Manual (C1207)*, a valuable instructor and handy reference guide for all levels of modelers. Besides teaching both basic and advanced techniques, the video and the manual include valuable technical tips from the experts.

Have fun and enjoy creating realistic terrain and landscaping on your layout.

# THE MOUNTAIN VALLEY SCENERY KIT CONTENTS

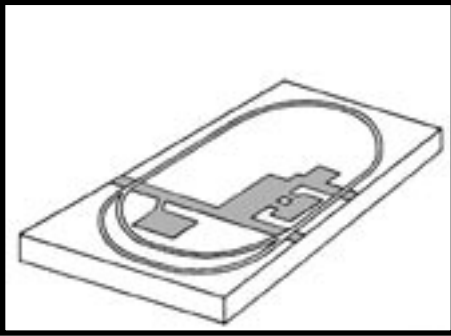
Listed below are the items contained in the Mountain Valley Scenery Kit.

Description	Quantity
Instruction Booklet .....	1
Pattern Sheet .....	2
Buff Fine Ballast .....	25 cu. in.
Scenic Cement .....	22 fl. oz.
Sprayer Head.....	1
Plaster Cloth.....	20 sq. ft.
Lightweight Hydrocal® .....	1 qt.
Rock Mold .....	1
Craft Sticks .....	2
Strip of Liquid Pigments.....	1/8 fl. oz. ea.
Burnt Umber, Yellow Ocher, Black	
Foam Pad Applicator .....	1
Green Blend Blended Turf.....	54 cu. in.
Disposable 4 oz. Cup with Sifter Lid .....	1
Earth Undercoat Earth Colors Liquid Pigment .....	8 fl. oz.
Burnt Grass Turf .....	2.9 cu. in.
Yellow Grass Turf.....	2.9 cu. in.
Earth Turf .....	2.9 cu. in.
Soil Turf .....	2.6 cu. in.
Medium Green Coarse Turf.....	26 cu. in.
Green Poly Fiber.....	loose fiber
Buff Talus (Rock Debris).....	6 oz. vol.
Mix of Fine & Medium	
Tree Armatures (3" to 5" tall).....	6
Hob-e-Tac Adhesive .....	1 fl. oz.
Dark Green Clump-Foliage .....	45 cu. in.
Light Green Clump-Foliage.....	45 cu. in.
Medium Green Clump-Foliage.....	45 cu. in.
Harvest Gold Field Grass .....	1 package

Additional items needed but not included (most are common household items):

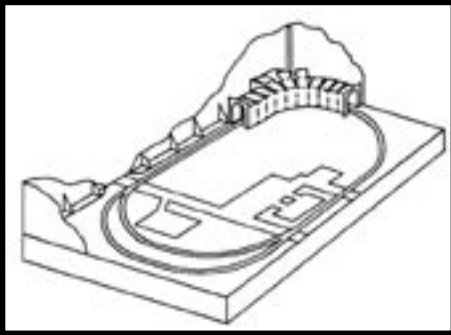
- graduated measuring cup
- masking tape
- pencil
- newspapers
- scissors
- Scenic Glue (S190) or white glue
- sprayer bottle
- drinking straw or eyedropper
- Measuring spoons (1/8 tsp., 1/4 tsp., 1 tsp., 1 T.)
- 2 cup (or larger) container such as cut off plastic two liter soda bottle or half gallon milk jug
- small cups (approximately 4 to 8 oz.)
- hobby (X-Acto) knife or Foam Knife (ST1433)
- rectangular cake pan or paint roller tray
- track cleaner or 600-grit wet/dry sandpaper
- 17 sq. ft. corrugated cardboard, hardboard or Profile Boards (ST1419), see chart on page 12 for size for each piece needed
- 1 pint flat latex house or wall paint in an "earth tone" color
- pan or bowl for water
- paint brush (1 1/2" to 2" wide)
- paper towels

®Product of US Gypsum



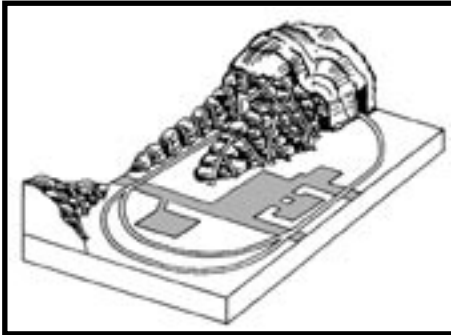
### I. INSTALL RAILS AND ROADS

Lay and install your roadbed and track. Plan and lay streets and roads, then ballast the track (pages 8-11).



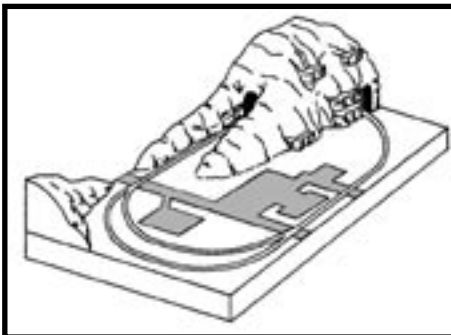
### II. CONSTRUCT TERRAIN SUBSTRUCTURE

Trace and cut out terrain profiles. Attach mountain profiles, tunnel, and tunnel access supports to base. Attach tunnel entrances to tunnel (pages 12-16).



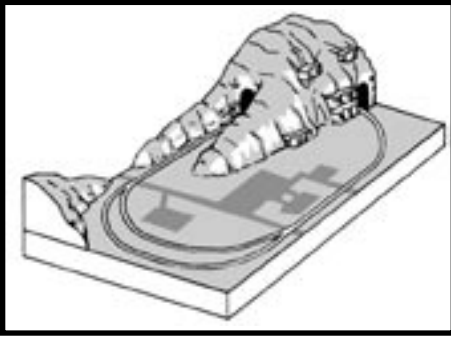
### III. BUILD MOUNTAIN SHAPES

Use newspaper wads to build the mountain shapes (pages 16-19) and Plaster Cloth for a hardshell terrain.



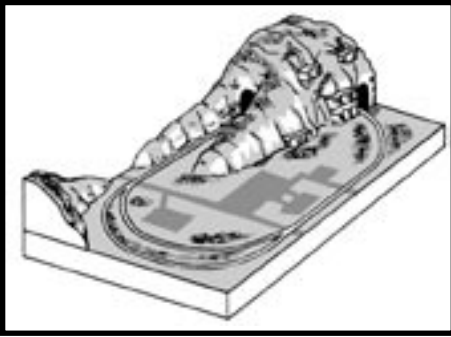
### IV. MAKE AND INSTALL ROCK CASTINGS

Make and install rock castings. Color rock castings after installation (pages 20-23).



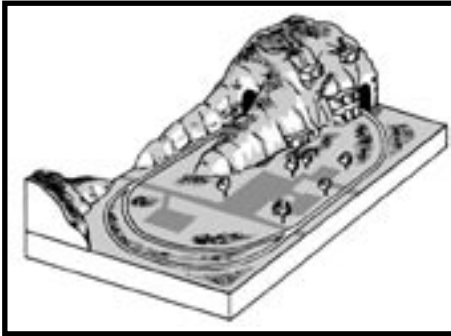
### V. ADD LOW GROUND COVER

Color the base with Earth Undercoat Liquid Pigment and sprinkle Blended Turf. Blend in additional Fine Turf colors (pages 24-27).



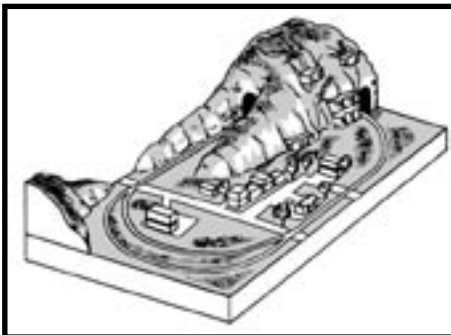
### VI. ADD MEDIUM GROUND COVER

Add and secure Talus (Rock Debris). Attach Poly Fiber. Apply Coarse Turf. Highlight areas with Fine Turf (pages 27-29).



### VII. ADD HIGH GROUND COVER

Assemble and install trees on layout. Attach Clump-Foliage. Plant Field Grass (pages 29-32).



### VIII. DETAILING

Learn new detailing techniques. Remove masks, clean your track and start railroading (pages 33-35).

### IX. FIX-UP AND CLEAN-UP

# BEGIN YOUR LAYOUT

Model railroads are generally built to scale which means everything on the layout is built to a specific ratio to what it is in the real world. In model railroading there are a number of common scales; HO scale is the most commonly modeled. HO scale is 1:87 which means an inch on the model represents 87 inches in the real world. The track plan and layout pictured on the box and featured in this kit are in HO scale. This layout includes a simple oval track plan with an inside loop, 30" tunnel, and is 25% mountains and uneven terrain. For the sake of this booklet, we will assume you are modeling our layout and scale. However, you may model in any scale you choose and modify the featured plan and instructions to suit your chosen scale and layout.

## PRIME THE BASE

Before you begin actual construction, paint your base with a flat, latex house or wall paint in an earth tone. If your base is made of plywood or other hardboard material, it will seal the surface. If your base is Styrofoam in a non-earth color, the paint will cover it. Allow to dry thoroughly before proceeding with the next step.

## I. INSTALL RAILS AND ROADS

Read through all instructions in this section before beginning.

If you have already fastened your track to your base, skip #1 - "Lay Roadbed and Track."

The layout and track plan should be finalized before proceeding any further. While modifications are always possible later, it is easier to plan ahead. This avoids wasting time and materials. The track is the heart of a layout. It must be laid correctly or a train will not run.

If you have not installed your track yet, use our suggested plan on page 9 (Fig. 1). You can also use the plan that came with your train set, or your own plan from a track plan book. We recommend sectional track for your layout. See the track plan and requirements on page 40. If you choose to use flexible track, follow Fig. 1 and manufacturer's instructions for laying it.

### 1. LAY ROADBED AND TRACK:

A raised roadbed is optional. You may prefer to fasten your track directly to your base, or your track may already have a raised roadbed. If you want to add a raised roadbed but do not have one yet, it is available at your local hobby shop.

**NOTE:** We recommend that you use our revolutionary SubTerrain System. The SubTerrain System consists of foam Risers, Incline Sets, Profile Boards and

***TECH TIP:** A smooth flat surface is needed as a base on which to construct a layout. Plywood (1/2" A/C grade) and SubTerrain Foam Sheets are two commonly used surfaces. You may want to build a sturdy framework under your base to provide additional strength.*





Foam Sheets. Risers and Inclines raise your roadbed off the base, and provide for low-lying areas, hills and mountains. The foam components are lightweight and you can create any terrain you wish.

The roadbed we recommend is Woodland Scenics Track-Bed, which costs less, has a quieter, smoother operation and is compatible with cork. Track-Bed comes in strips, sheets and 24-foot continuous rolls for an easy and almost seamless application. Other roadbed materials like cork, styrofoam, various fiberboards or wood can also be used.

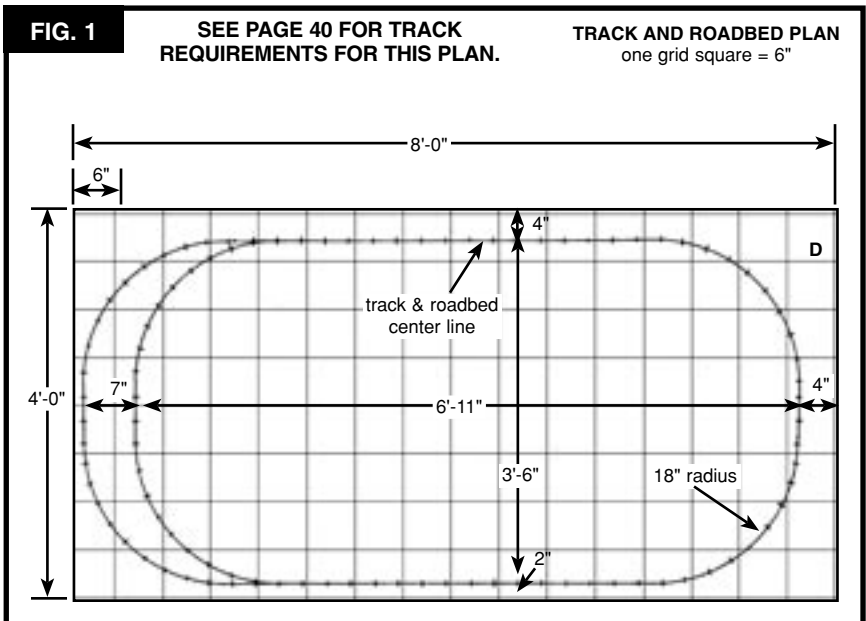
The drawing in Fig. 1 indicates how we laid our track. **NOTE:** Center line of track is indicated in this drawing. Also, each square in the track diagram in Fig. 1 represents a 6" square on your base.

A. Temporarily connect your track sections according to your track plan (page 40 for our track plan requirements).

B. Locate track on your base according to dimensions in Fig. 1. **NOTE:** All dimensions are to center of track, not edge. If not using roadbed, attach track directly to base according to manufacturer's instructions.

C. If you are using a separate roadbed, lightly trace around the inside and outside edge of track to mark location of track on base. Remove track from base, and attach roadbed, centered, over track location which you have traced on the base. The method used to attach roadbed to a base depends somewhat on the roadbed and base materials. Follow manufacturer's suggestion, or ask at the hobby shop where you purchased your roadbed, for the best method to use. Reassemble track and center on the roadbed.

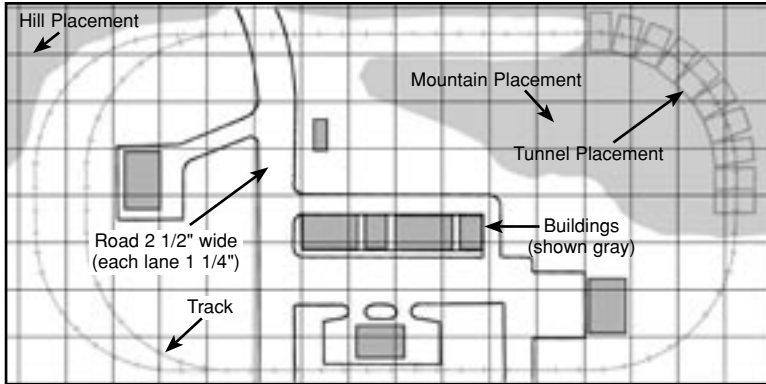
D. Test track by attaching power supply and running the train. Adjust as necessary. Then remove train and power supply.



## 2. PLAN AND LAY STREETS AND ROADS:

A. Any buildings you plan to add later will need access by road and/or by rail. Streets and roads for those buildings may be indicated now or may be added later. If you plan to add them later, skip to D. If you wish to indicate where streets and roads will go at this time, see Fig. 2 for an example of road and building placement. This drawing of roads and buildings represents the layout shown in the color photo on the front of this box. Your actual road and building placement will depend on the buildings you decide to place on your layout. Be sure to consider where you will place mountains, tunnels and other terrain features.

**FIG. 2** STREET AND ROAD PLAN



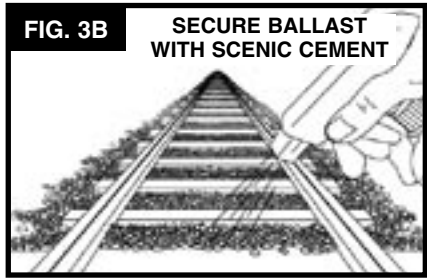
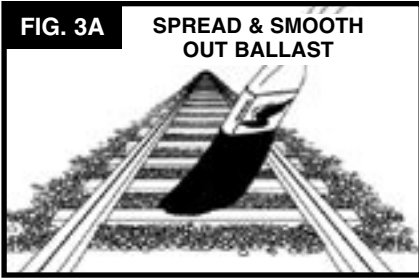
If you are modeling in HO scale, allow 1 1/4" (which represents about 9') for each lane of a road or street. A two-lane street or road would be 2 1/2" wide (which represents about 18').

Adding parking on both sides would increase the total width to about 4 1/2" (which represents 32 1/2'). It appears realistic and doesn't waste a lot of valuable layout space.

B. To add streets and roads, remove landscaping materials from the base first, by sanding with sandpaper (if your surface is rough, Woodland Scenics Flex Paste works ideally as a surfacer and a primer). Paint the base with gray latex house paint and allow to dry. If you add roads now, they can be painted directly on the clean, dry base. When the paint is dry, use masking tape or paper towels to protect it until you have completed your terrain and landscaping. **NOTE:** Woodland Scenics offers a complete Road System. It includes Paving Tape, Smooth-It and Top Coat paints. It is an easy, fast way to make roads, highways, sidewalks, parking lots and other paved areas on your layout.

C. If you decide to add paved surfaces later, construct them from the Road System, smooth cardboard, or styrene plastic sheets, then paint and glue them in place later.

**TECH TIP:** A very light coating of Vaseline (petroleum jelly) or Hob-E-Lube White Grease rubbed on rails before spraying Scenic Cement will make them easier to clean when construction is completed. At the same time, a drop or two of lightweight household machine oil such as Hob-E-Lube Ultra-Lite Oil applied to switch points and moveable throws will help to protect them.



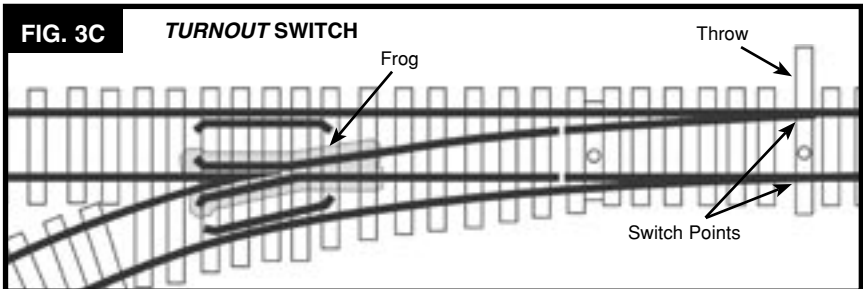
**3. BALLAST THE TRACK:**

A. Cut off one corner of the bag of Ballast and pour Ballast down the center of the track and edges to cover roadbed. Use a dry paintbrush to spread and smooth out the Ballast (Fig. 3A). The entire roadbed should be covered but all of the rails and the tops of the ties should be free of Ballast. **NOTE:** If you are including a tunnel on your layout, the track inside the tunnel area needs to be covered with Ballast only as far as you can see into the tunnel (3" - 6" from entrance).

B. Shake the bottle of Scenic Cement thoroughly to mix it. Attach the spray head. Turn the adjustment to spray a fine mist. From a distance of 18" to 24", begin to lightly mist the Ballast with Scenic Cement to hold it in place without dislodging it. Gradually move sprayer in close while you spray Scenic Cement, thoroughly soaking the Ballast to permanently attach it (Fig. 3B). **NOTE:** After each use, remove spray head and thoroughly wash it with hot water and soap. Pump hot water through spray head until water is clear of all Scenic Cement.

C. Top of rails must be free of all Scenic Cement and Ballast for trains to run smoothly. Clean rails with 600-grit wet-dry sandpaper or a track cleaner recommended by your local hobby shop. Repeat cleaning any time your train runs intermittently because the rails provide the electrical contact your train needs to run.

**NOTE:** Keep glue and Ballast away from switch points, throws, and frogs. Do not allow Ballast to interfere with movable parts of a switch (Fig. 3C). To secure Ballast in those areas, use an eyedropper or straw to place the Scenic Cement exactly where you want it. Cover all track before adding terrain and landscaping to protect rails from sprays and debris.



**PRODUCT TIP:** Scenic Cement is a multi-use, non-toxic, water-based medium that is used as an adhesive to seal and protect Ballast, Turf and other landscaping products. It can be sprayed or brushed on a surface. It dries clear, flat and is often used as a protective overspray.

# TERRAIN

Terrain can be defined as the earth contours or physical features of a tract of land. Terrain can include rolling hills and broad valleys, mountains and narrow canyons, flat plateaus and undulating prairies. The techniques you learn with this kit can be applied to any layout or model.

## II. CONSTRUCT TERRAIN SUBSTRUCTURE

Before beginning this section, lay out pattern sheets 1 and 2. This will make steps 1-4 easy to understand. Read through all instructions in this section before beginning.

In this section, you will trace and cut out the mountain profiles, gussets, tunnel, tunnel entrances, and tunnel access support using the patterns provided (on enclosed pattern sheets) and corrugated cardboard for profile material or Profile Boards. These pieces will become the substructure or skeleton on which the terrain features are constructed. (Other materials may be used for mountain profiles - see Tech Tip below.)

Next, you will glue the profiles in place. Finally, you will attach the tunnel, tunnel entrances, and tunnel access support to the layout. When the layout is complete, the tunnel will act as a view block, allowing the train to play peek-a-boo with the viewer.

### 1. TRACE AND CUT OUT TERRAIN PROFILES:

A. Cut out all pattern pieces (A-H) from pattern sheets. **NOTE:** Cut pattern H on outside edge only. Fig. 6B.

B. You will need about 17 square feet of corrugated cardboard (profile material). The minimum size of profile material required for each pattern piece is shown in chart at right. Check patterns to see direction of corrugation. **NOTE:** Grain of corrugated cardboard runs same direction as height in chart.

PROFILE MATERIAL REQUIREMENTS		
Pattern	Width	Height
A	18"	8"
B	28"	8"
C	67"	13"
D	28"	13"
E	30"	13"
F	13"	19"
G (2)	4 3/4"	5"
H	6"	5"

C. Lay pattern (A, B, C, D, E, F and G) on profile material. Tape in place. Be certain corrugation grain is running the direction shown on the pattern or your

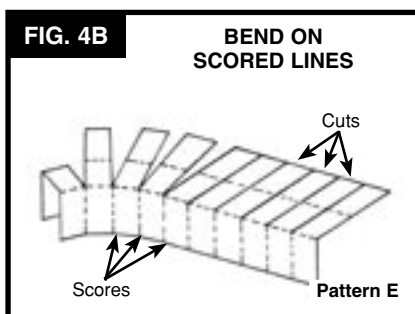
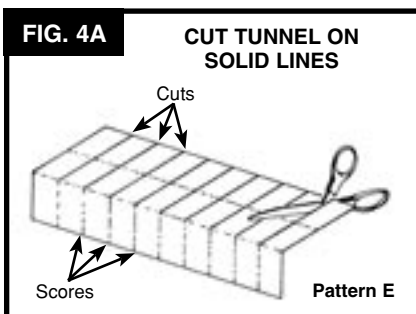
**TECH TIP:** Large, corrugated cardboard cartons may be available at your local appliance or bedding store. Cut corrugated cardboard with utility knife, hobby knife or scissors. If you must piece a profile together from two pieces of corrugated cardboard, butt the joint and tape on both sides. Hardboard (such as Masonite) may be used in place of corrugated cardboard for mountain profiles. Woodland Scenics Profile Boards are the perfect product for the profiles. Add 1/2 inch all around the pattern to compensate for the interlocking feature. You can trim later. There will be no need to create gussets. Just interlock the pieces and glue all around with Low Temp Foam Glue Gun (ST1445). Only corrugated cardboard or 1/4" Woodland Scenics Foam Sheets should be used for the tunnels, due to the need for flexibility. If using hardboard or foamboard, do not include glue tabs indicated on patterns. Cut hardboard with a saw. Cut foamboard with a knife or hot wire cutter. Warning: Utility knife or hobby knife can cut surface under profile material, so protect the surface you are working on with an extra layer of cardboard.

model will not be strong enough. Use a pencil or pen to trace around all pattern pieces.

D. Use a utility knife or scissors to cut out (on the solid lines) mountain profiles (A-D) made of corrugated cardboard. Lightly score but do not cut all the way through on the dotted lines. If you have cut profile C in two pieces, butt the two pieces together as indicated on pattern pieces and tape on both sides. Warning: Utility or hobby knives can cut surface under profile material, so protect the surface you are working on with an extra layer of cardboard.

E. Cut out the tunnel (E), tunnel access support (F), and (2) tunnel entrances (G) on solid lines (as shown in illustration of tunnel, Fig. 4A). Lightly score Patterns E and F on dotted lines but do not cut all the way through. Fold on the scored lines. (Figs. 4B, 6A and 9A.)

Mix a thin solution of Scenic Glue or white glue and water (1:1). Spread a thin layer of white glue mixture on back of gusset pattern H. Glue to profile material. Let dry. Use a straight edge and a utility knife, hobby knife or scissors to cut out individual gussets (30) ( Fig. 6B).



## 2. ATTACH MOUNTAIN

A. Fold all glue tabs to the inside of pattern. (Scored edge will be to the outside.) Fig. 5 and 5B.

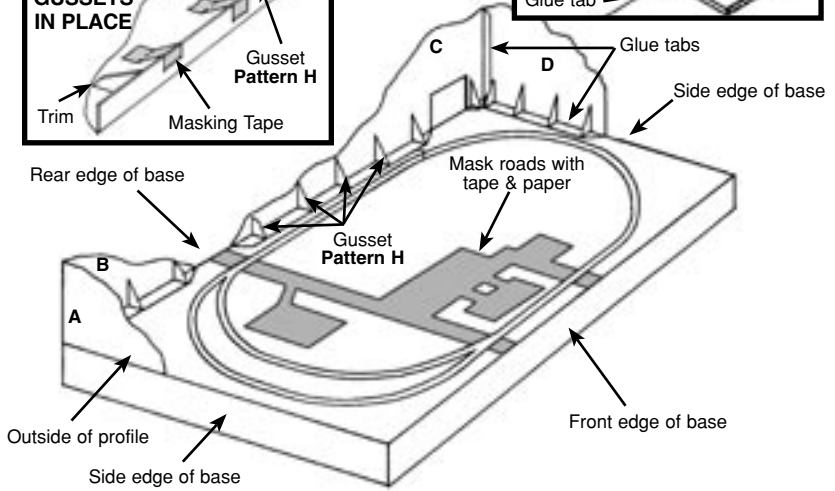
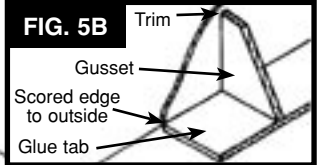
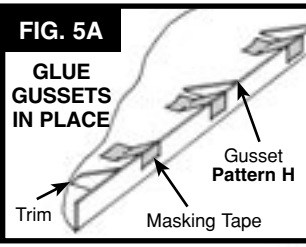
B. Using white glue, glue all gussets to the inside of profiles A, B, C, and D as shown in Figs. 5 and 5A. Use masking tape to hold in place until glue dries (Fig. 5A). Trim gusset if taller than mountain profile (Fig 5A and 5B).

C. Glue vertical glue tab on profile B to inside of profile A. Glue vertical glue tab on profile C to inside of profile D, (Fig. 5). Hold in place with masking tape for positioning mountain profiles A, B, C and D on layout. Mountain profiles B & C should be flush with the rear edge of the base; the side mountain profiles A & D should be flush with side edges of the base. Glue profiles to base by attaching glue tabs to base with white glue. Use staples, tacks or masking tape to hold in place while drying.

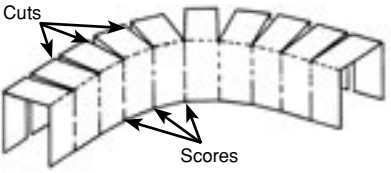
D. After glue dries, carefully remove masking tape from areas that will be visible when the layout is finished.

**TECH TIP:** To fill and strengthen scored edges of corrugated cardboard, corners and gaps between mountain profiles and base, use Woodland Scenics Flex Paste (C1205). Spread Flex Paste with putty knife, let dry and sand. Then, apply a second coat of Flex Paste, let dry and sand.

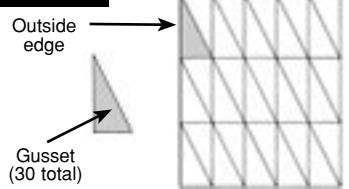
**FIG. 5 GLUE PROFILES IN PLACE**



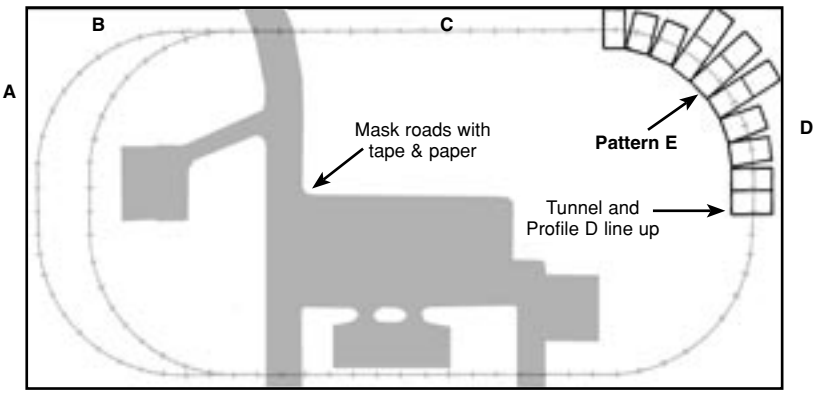
**FIG. 6A TUNNEL FOLDED AND READY TO PLACE ON LAYOUT**



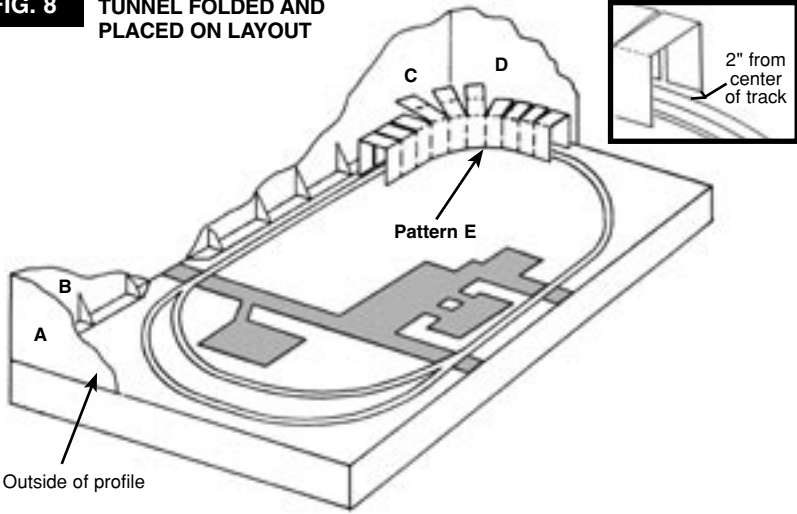
**FIG. 6B GUSSET PATTERN H**



**FIG. 7 TUNNEL FOLDED AND PLACED ON LAYOUT**



**FIG. 8 TUNNEL FOLDED AND PLACED ON LAYOUT**



### 3. ATTACH TUNNEL AND ACCESS SUPPORT TO BASE:

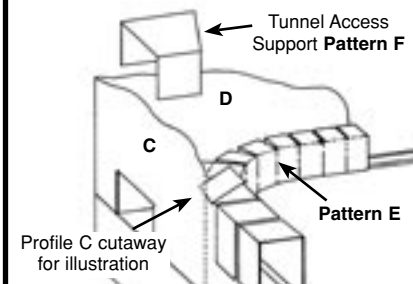
A. Cuts and scores in the corrugated cardboard tunnel (E) will allow you to bend the tunnel into a curved shape (Fig. 6A).

B. Place the tunnel in the location indicated in Fig. 7 and 8, making sure that the front edge of the profile material (D) and tunnel (E) line up. Note that the scored side of tunnel is toward the front and center of layout and the cut side with flaps is toward the rear and side of layout. Leave the three flaps unattached at the back side of tunnel for access as indicated in Fig 7 - 9B. **Be sure to leave at least 2" on either side of the tracks center line so a train won't hit sides of tunnel.** Secure tunnel to base with Scenic Glue or white glue.

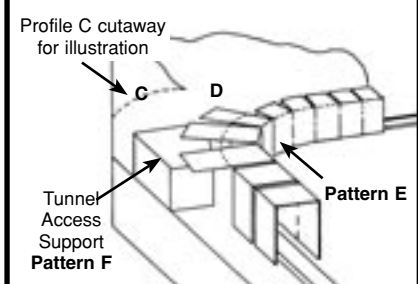
C. Place tunnel access support (F) in position as shown in Fig. 9A and 9B. Note that the three unattached tunnel flaps rest on top of the tunnel access support (Fig. 9B). Glue in place. Let all glue dry before continuing.

D. Roll a piece of rolling stock through the tunnel to check clearance before you begin to build the mountain. Adjust for clearance if necessary.

**FIG.9A LIFT TUNNEL FLAPS & PLACE TUNNEL ACCESS SUPPORT**

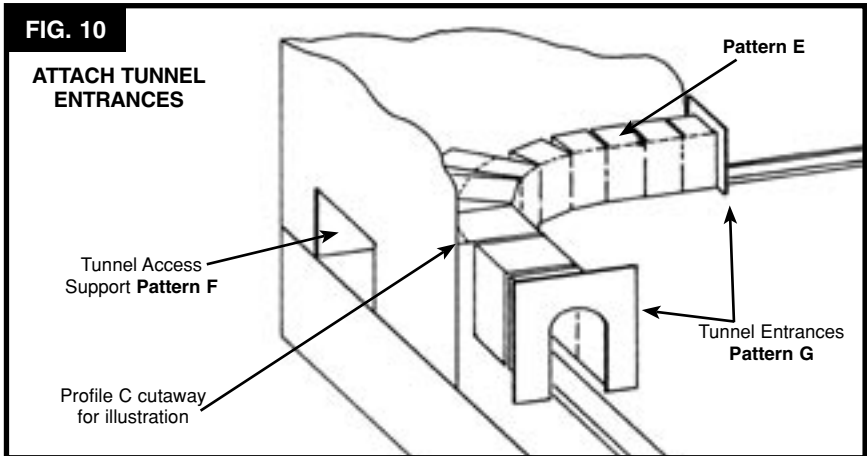


**FIG. 9B PLACE TUNNEL FLAPS ON TOP OF TUNNEL ACCESS SUPPORT**



## 4. ATTACH TUNNEL ENTRANCES:

- A. Use Scenic Glue or white glue to attach tunnel entrances (G) to ends of tunnel. (Fig. 10.) Be sure each side of an entrance is an equal distance from center of track.
- B. Roll a piece of rolling stock through the tunnel again to be sure of clearance before proceeding. If it does not clear, adjust as necessary.
- C. Cover track and roadbed with masking tape to protect them during the next steps.



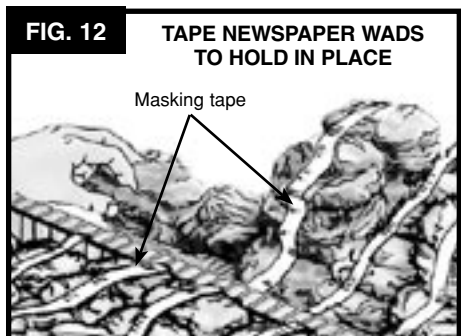
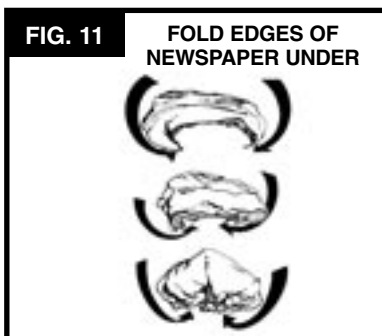
## III. BUILD THE MOUNTAIN SHAPES

Read through all instructions in this section before beginning.

In this section, you will complete the terrain construction by building hills and mountains. We'll show you how to create the terrain shapes pictured on the box, but these shapes are just one way of doing a layout. If you change the terrain shapes for your layout, the same techniques you learn in this booklet will apply. If you should construct a layout that is different than the one we show, you may need more or less of a specific product.

### 1. NEWSPAPER WADS:

- A. Tightly wad up several sheets of newspaper. Begin at the outside of the sheet of newspaper and roll the edges under to form a rounded pillow shape wad (Fig. 11).





This pillow shape wad is the easiest to stack up to create hills and mountains.

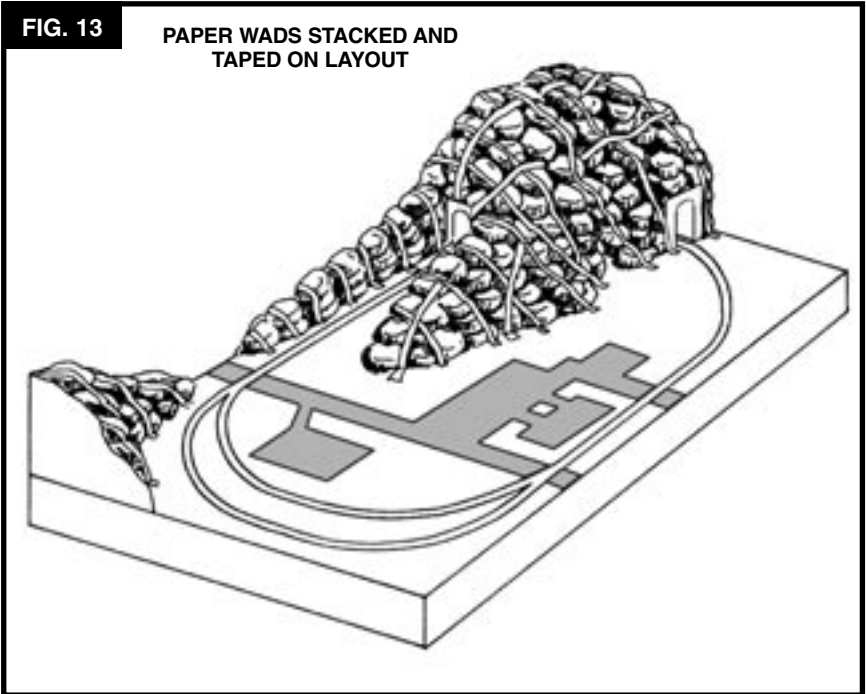
B. Use masking tape to hold newspaper wads as you form the contours. **NOTE:** You may want to cut a number of 8" strips of masking tape before this step.

C. Check the track for sufficient clearance for the engine and rolling stock you intend to use on your layout. If you have too many newspaper wads, remove some or push them in a little and retape to compact them. Be sure wads will not interfere with operation of trains on the track.

D. If you have trouble visualizing those mounds of newspaper wads as terrain features, place a sheet of newspaper over the wadded up paper and wet it down using sprayer and water. The newspaper sheet will conform to the shape that has been created and provide a better idea of how the hills and mountains will look. Then add or subtract newspaper wads as desired.

**FIG. 13**

**PAPER WADS STACKED AND  
TAPED ON LAYOUT**



## 2. PLASTER CLOTH:

Next, a hard terrain shell made from Plaster Cloth is applied on top of the newspaper wads. You will cover all of the mountains surfaces, including the corrugated cardboard tunnel entrances, with strips of Plaster Cloth. Plan to work in a systematic way from one side of layout to the other and from rear of layout to the front.

**PRODUCT TIP:** *Plaster Cloth is a quick and simple way to create a durable terrain shell. The plaster impregnated material is dipped in water to activate the plaster and placed over newspaper wads. It dries to a hard shell.*

Notice that one side of the Plaster Cloth is smooth and the other side is slightly “bumpy.” The Plaster Cloth should be used with the “bumpy” side up to make more plaster available for smoothing into the contours.

**TECH TIP:** *The height and size of your mountains may vary somewhat from those in the picture. To be sure you have enough Plaster Cloth for your layout (if different from ours), you may want to use a roll of paper toweling to create a mock-up of the Plaster Cloth strips. Measure out 30' of paper toweling. (That is the length of the Plaster Cloth included in this kit.) Trim or fold toweling to an 8" width. (That is the width of the Plaster Cloth.) Cover all mountain surfaces, including the tunnel, with strips of paper towels. Begin on one side of the layout with the pieces laid rear to front. Work toward other side of the layout. Overlap sections just slightly, about 1 1/2" to 1". Allow 1/2" to 1" at each end for fold over. Allow for depressions in the contour. If you run out of paper toweling before you are done covering the newspaper wads, you may either rearrange or remove some paper wads or cut more toweling and measure the length to determine the additional amount of Plaster Cloth you may want to purchase to cover a larger area.*

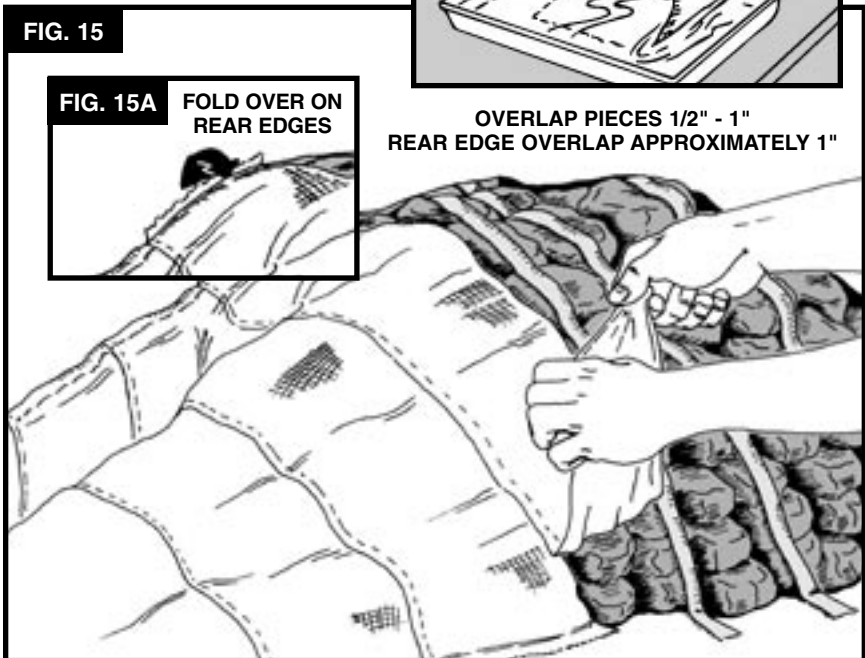
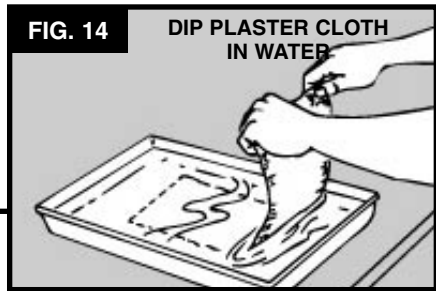
A. Unroll a piece of Plaster Cloth on top of the newspaper wads and along one side of layout over the first area you will cover. Tear or use scissors to cut a piece of Plaster Cloth from the roll as close as possible to the size needed to cover that area. (A manageable length of Plaster Cloth is probably not more than 1' to 2'. For areas longer than 2' use shorter pieces of Plaster Cloth and overlap edges 1/2" to 1"). Briefly dip this piece of Plaster Cloth in a pan of water such as a cake pan or paint roller tray (Fig. 14) and lay it on the intended area. The edge of the Plaster Cloth should extend approximately 1" beyond the mountain profiles on the side and rear edges of the mountains (Fig. 15). Fold over the excess Plaster Cloth evenly on top of itself to create a clean, finished edge that is flush with the edge of the mountain profile and is extra strong (Fig. 15A). Press this edge firmly on the top of the profile's edges to adhere it. Wet hands with water and rub your fingers over the Plaster Cloth to distribute the plaster so all holes in Plaster Cloth fabric are filled and the surface is smooth. You may want to allow some wrinkles in Plaster Cloth for a slight variation in the terrain. **NOTE:** Plaster Cloth spans the wads of newspaper. Newspaper wads serve as a support for wet Plaster Cloth. The Plaster Cloth does not have to adhere to the newspaper wads. When Plaster Cloth dries, it is self supporting.

B. Measure and cut or tear another piece of Plaster Cloth and place it next to the previous piece, overlapping the first piece just slightly, about 1/2" to 1". Fold over rear edges as before and press to adhere them. Don't forget to fill in Plaster Cloth fabric holes and smooth each piece with wet fingers as you go.

C. Continue adding 1' to 2' long Plaster Cloth pieces in the same manner, working from one side of the layout to the other side. Each rear, front or side edge of Plaster Cloth that meets the profile or the base should be pressed down firmly.

D. Be sure to cover the entire face of corrugated cardboard tunnel entrances with Plaster Cloth strips so they will look like the rest of the mountain when painted. To cover corrugated cardboard entrance thoroughly, wrap the strips of Plaster Cloth to the inside of tunnel. Press the edges of the strips firmly to adhere them to the inside.

E. While Plaster Cloth is still damp, periodically check all the edges where the Plaster Cloth meets the rear or side profiles. One more time, press Plaster Cloth firmly to the top edge of the profiles and to the base and smooth with fingers.



F. Allow the Plaster Cloth to dry completely.

G. If Plaster Cloth is not attached to profiles or base after it dries, or if it detaches later, use Scenic Glue or white glue to attach it.

**NOTE: This kit includes enough Plaster Cloth for a single layer of hardshell following our design. If you have changed the design or want to add an additional layer of hardshell for greater strength, you may need to purchase more Plaster Cloth.**

## IV. MAKE & INSTALL ROCK CASTINGS

Read through all instructions in this section before beginning.

In this section, you will prepare the mold, make rock castings, install them on your layout and color them. This will complete the terrain instructions in this booklet.

Contents of Lightweight Hydrocal bag may have settled. Turn bag upside down and gently shake for 30 seconds to mix before using. To make rock castings, Lightweight Hydrocal is added to water in the ratio of 5:2 - five parts Lightweight Hydrocal are added to two parts water while stirring. Mix well. To be absolutely certain you have measured the amounts correctly, measure water and Lightweight Hydrocal into separate containers before mixing them together.

**NOTE: Do not shake measuring container (teaspoon, tablespoon or cup) of Lightweight Hydrocal to level it. This distorts the ratio by increasing the actual amount of Lightweight Hydrocal in the container. Instead, level it with a craft stick.**

### 1. MAKE ROCK CASTINGS:

A. Coat inside of Rock Mold by pouring and swirling a small amount of “wet water” inside each section. This will help disperse air bubbles. Pour out excess “wet water” and save it for wetting mold sections before future pours.

***TECH TIP:** “Wet water” is useful in many ways when modeling terrain and landscape. Keep some handy in container such as a used spray bottle. Or keep in a clean bottle and temporarily place enclosed spray head on that bottle to spray “wet water.”*

***TECH TIP:** Support mold with wadded newspapers to hold mold level during and after pouring until rock castings are dry.*



B. To make a pour that will fill all three sections of the rock mold, measure 6 tablespoons of water into a flexible bowl. (A disposable container can be made by cutting top off of a two-liter plastic soda bottle or a half gallon milk jug.) Measure one cup Lightweight Hydrocal into another container. Add measured Lightweight Hydrocal to measured water. Stir well with craft stick and immediately pour into mold. Fill to top of mold but don't overfill. Tap mold gently on table to cause any air bubbles to rise to surface. Allow rocks to thoroughly dry. Rocks will probably be ready to demold after 2 hours.

C. After each pour, immediately wash measuring spoons, mixing container, and craft stick before the Lightweight Hydrocal mixture is completely set.

**WARNING: Do not wash plaster down drains as it will collect in low places in pipes and clog the sewer lines.** Suggestion: Use a bucket of water to wash equipment and dispose of waste water outside.

D. Release rock castings by carefully turning mold inside out. Break off any “lip” - the extra plaster formed outside of the mold cavity. Wash mold after each use to remove any plaster that has stuck to it. A rock that breaks during release is still useful on an layout as broken rocks are found in nature and simply add variety.

E. Repeat previous steps until you have made a total of three pours for a total of nine rocks. You should have some dry Lightweight Hydrocal left over at this time. This will be needed in a later step to attach rock castings to layout.

## 2. INSTALL ROCK CASTINGS:

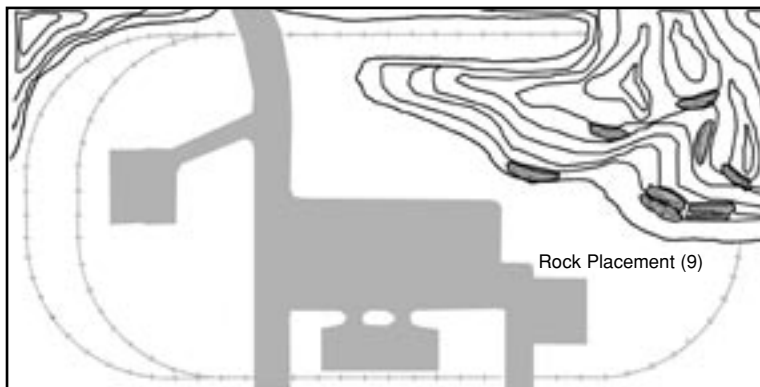
A. See Fig. 16 for suggested placement of the rock castings. (Of course, you may place rock castings anywhere you wish but they will look more natural on a steep or vertical hillside. It is better to place rocks in groups rather than equally spaced out. Be sure to keep the rock’s strata - its layers - horizontal.) Trial fit in place. You may need to push in a little on the Plaster Cloth terrain shell to recess the rock castings and to get the realistic look of rocks projecting out of the hillside. If needed, a cut can be made in the Plaster Cloth with a hobby or utility knife in the area where a rock casting will be installed. This will allow you to collapse the hillside a little further and to recess the rock more effectively.

B. You may break a rock casting into two pieces to give you more variety and options in placement on layout. These two pieces may be used adjacent to each other or they can be separated. You may also flip rocks upside down providing still more variety.

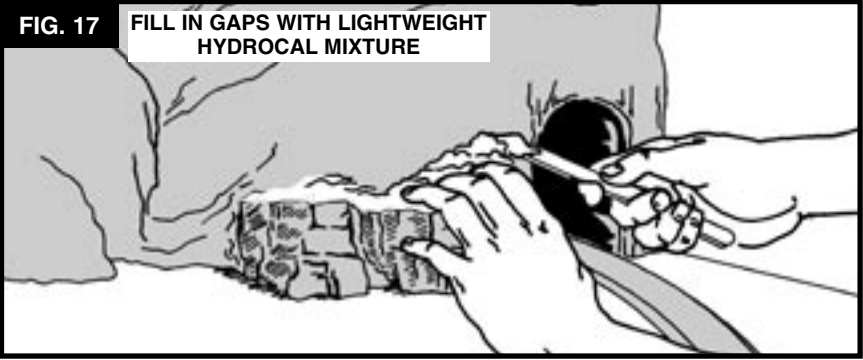
C. Once you have decided where to place your rocks, it is time to permanently attach them to your layout. You will install three rocks at a time for efficient use of Lightweight Hydrocal mixture as an adhesive.

FIG. 16

NOTE SHAPE OF LINES ON MOUNTAINS AND PLACEMENT OF ROCK CASTINGS



**PRODUCT TIP:** If you want more rocks and/or a wider variety of rock types, your hobby shop sells Lightweight Hydrocal and a large number of different Woodland Scenics' Rock Molds.

**FIG. 17****FILL IN GAPS WITH LIGHTWEIGHT HYDROCAL MIXTURE**

D. Add 5 level tablespoons of Lightweight Hydrocal to 2 tablespoons of water and mix well with a craft stick. This should be enough to install three rocks.

**NOTE: Both the rock castings and the Plaster Cloth terrain shell must be wet for the Lightweight Hydrocal to be effective as an adhesive.**

E. Briefly soak three rock castings in water. Wet the Plaster Cloth terrain base with water where the casting are to be attached (use a sponge or spray bottle).

F. With a craft stick, generously spread a thick layer of the Lightweight Hydrocal mixture on the back of the rock castings and press into place on the Plaster Cloth. Keep mixture off rock faces. Hold in place until setting begins.

G. If any of the Lightweight Hydrocal mixture is left over, use it if necessary to fill in gaps behind these rock castings (Fig. 17). Smooth out the Lightweight Hydrocal mixture and blend it into the Plaster Cloth with a paintbrush dipped in water. Keep Lightweight Hydrocal mixture off rock faces.

H. Be sure to rinse craft stick, mixing bowl and brush thoroughly in water before the plaster dries and hardens. Repeat steps D through G until you have attached all of the rock castings to the layout.

I. If you still have any gaps between the rock castings and the Plaster Cloth terrain shell, they should be filled before continuing. Add 5 level tablespoons of Lightweight Hydrocal to 2 tablespoons of water and mix well. Use this mixture to fill in any gaps. Try to make the terrain flow smoothly between the rock castings and their surrounding areas. If there are any big gaps, fill them with paper wads first and then cover with Lightweight Hydrocal mixture.

J. Allow to dry completely at least 12 hours or overnight before coloring.

### **3. COLOR ROCK CASTINGS:**

**NOTE:** Pigment washes are not permanent until sprayed with Scenic Cement. See step G.

A. Before coloring rocks, see photos on box as an example. Use three small cups or glass containers. Open pigment containers, carefully pinching tabs on containers together. Avoid splashing pigment or washes. **NOTE:** Save all pigment washes to use in the section “FINISHING TOUCHES”.

B. Add water to pigments according to table (page 23) and mix all of them thoroughly with a craft stick to create washes.

C. These washes will be used to create a random leopard spot pattern. Re-stir each wash before each use because pigment will settle to bottom of wash. Dip the foam pad applicator in the Yellow Ocher wash. Dab random spots of Yellow Ocher wash on about 1/3 of each rock casting (Fig. 18). Rinse the foam pad applicator in water and squeeze excess water out. Dip the foam pad in the Burnt Umber wash and dab random spots of Burnt Umber wash on a different 1/3 of each rock casting. Rinse the foam pad applicator in water and squeeze excess water out.

	<b>CUP #1</b>	<b>CUP #2</b>	<b>CUP #3</b>
<b>WATER</b>	4 OZ. (1/2 cup)	4 OZ. (1/2 cup)	4 OZ. (1/2 cup)
<b>PIGMENT</b>	1/8 TSP. BLACK (looks black)	1/4 TSP. BURNT UMBER (looks brown)	1/4 TSP. YELLOW OCHER (looks yellow)

D. Dip the foam pad applicator in the Black wash and dab over the entire surface of each rock casting. Let the wash run into all the cracks and crevices. Allow to dry overnight.

E. Look at the rock castings after they are dry. If you want more color, randomly dab the rocks again with the color wash or washes of your choice. Allow to dry. Be sure that there is not any white plaster still showing.

F. If some parts of your castings are not accepting color and appear white or are too light, use a much higher concentration of color or even full strength Yellow Ocher or Burnt Umber Pigment to color them. Allow to dry completely.

G. When you are satisfied with the rock coloring, shake the bottle of Scenic Cement thoroughly to mix it. Attach the spray head and turn the adjustment at end of nozzle to spray a fine mist. Spray Scenic Cement on the rock castings to set the color. Allow to dry completely.

H. To accent the rocks' cracks, crevices and details, and to deepen the shadows, make a stronger wash consisting of 1/8 tsp. Black Pigment mixed with 2 oz. water. Dab on all rock castings, allowing wash to run into the cracks and crevices. Allow to dry, repeat if desired, and then spray with Scenic Cement to set the color.



**FIG. 18**

**DAB ROCK WITH  
PIGMENT WASHES**

# LANDSCAPE

After the terrain has been created on the layout, the next step is to add landscaping. This process will add color, texture, and realism to the layout as you model various types of vegetation.

We will be using a transparent wash and irregular application of various turf and other products in this section. There is no specific order in which many of the landscape materials must be added to a model or layout. In this kit we present one order of working but feel free to alter it a little, if you wish, or return to an earlier section to add more of a particular product. If you use our design and follow our instructions, you will have enough material to complete the layout pictured on the box. If your layout or methods differ from those illustrated, you may need more or less of a specific product. If you should need more, your local hobby shop will be able to supply you. Refer to page 39 for product names and numbers.

## V. ADD LOW GROUND COVER

Read through all instructions in this section before beginning. **NOTE:** You will be using Scenic Cement throughout this section. Always shake before using to mix thoroughly.

Low ground cover includes the base coloring and the smallest grasses and plants. It also includes dirt and soil. Initially, you will be adding low ground cover rather sparingly to your layout. Later, you will have the opportunity to add more ground cover if desired.

### 1. COLOR THE BASE AND SPRINKLE TURF:

A. In a bowl, mix 6 fl. oz. Earth Undercoat Earth Colors Liquid Pigment with 6 fl. oz. water (1:1 ratio) to make a wash.

B. Next, cut off one corner of the bag of Green Blend Blended Turf and fill (do not pack) the furnished 4 oz. cup. Place sifter lid on cup.

C. Use a 1 1/2" or 2" brush to apply the Earth Undercoat Pigment wash to only the flat base areas. Cover only an area about 2' x 2' at a time (Fig.19). This wash is somewhat transparent and should appear very irregular, with light and dark areas.

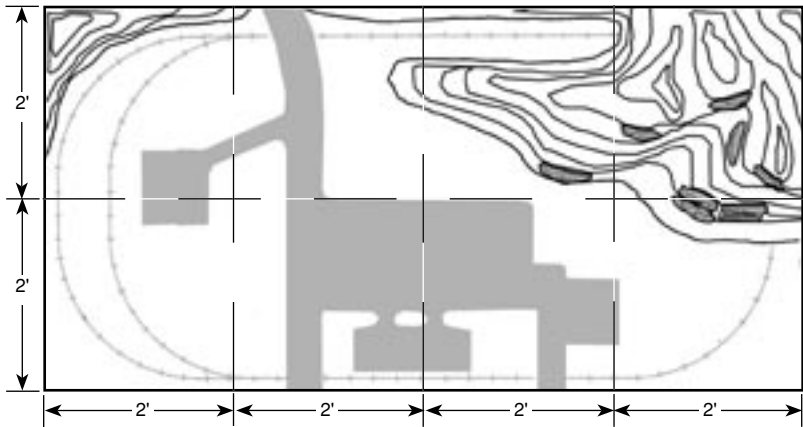
D. While an area is still wet with the Earth Undercoat Pigment wash, immediately sprinkle a very thin layer of Green Blend Blended Turf on the wet surface in a salt and pepper fashion. **Sprinkle a maximum of one full 4 oz. cup (furnished) per each 2' x 2' flat base area.** (Do not use more than this amount per each 2' x 2' area.) Hold cup so that you prevent the cap from coming off while sprinkling (Fig. 20). Fill cup again and repeat painting and sprinkling Green Blend Blended Turf in 2' x 2' squares until all flat base areas (except roads and track) are very thinly covered. If surface dries before you can sprinkle the Turf, apply wash to a smaller area at a time and sprinkle with Turf at once.

**PRODUCT TIP:** Woodland Scenics offers two different storage containers for applying landscape products. The 16 oz. Scenic Sifter (S193) comes with two interchangeable snap-on sifter caps in different sizes making it easy to apply Ballast, Turf and Coarse Turf to any layout. The 32 oz. Canister Shaker (S194) has a flip-top lid allowing you to shake, pour or spoon on product as needed. Blank labels are enclosed in each container for product identification.



**FIG. 19**

LAYOUT IS DIVIDED INTO AREAS APPROXIMATELY 2' X 2' FOR APPLICATION OF TURF, DO NOT WASTE TURF ON ROAD AND TRACK AREAS MASKED OFF.

**FIG. 20**

SPRINKLE GREEN BLENDED TURF ON WET EARTH UNDERCOAT PIGMENT WASH



E. Next, mix 2 fl. oz. Earth Undercoat Earth Colors Liquid Pigment with 4 fl. oz. water (1:2 ratio).

F. Fill half of the furnished 4 oz. cup with Green Blend Blended Turf.

G. Use a 1 1/2" to 2" brush to apply the Earth Undercoat Pigment wash to mountainous areas and tunnel entrances. Cover a 2' x 2' Plaster Cloth area (mountains and tunnel entrances) at a time (Fig. 19). Do not use on rock castings. This wash is somewhat transparent and should appear very irregular, with light and dark areas. A totally opaque layer of Pigment is not wanted or needed on the mountain areas, just enough to tint the white plaster.

H. While an area is still wet with the Earth Undercoat Earth Colors Liquid Pigment wash, immediately sprinkle a thin layer of Green Blend Blended Turf on the wet surface in a salt and pepper fashion (Fig. 20). **Sprinkle a maximum**

of one-half of the furnished cup (2 ounces by volume) of Green Blend Blended Turf per each 2' x 2' mountainous area. (Do not use more than this amount per each 2' x 2' area.) A sparse application of Green Blend Blended Turf with quite a bit of Undercoat Pigment wash showing through is natural looking in these areas. Cover all Plaster Cloth areas with the Undercoat Pigment wash so that no white shows through. Little or no Turf should be sprinkled on steep, vertical walls. If surface dries before you can sprinkle the Turf, apply wash to a smaller area at a time and sprinkle with Turf at once.

Continue applying wash and sprinkling Green Blend Blended Turf until all Plaster Cloth areas are covered. Later on, when you are all done adding the other landscaping, you will be able to add more Green Blend Blended Turf if you so desire.

Save the leftover Green Blend Blended Turf until you are ready for the section "FINISHING TOUCHES".

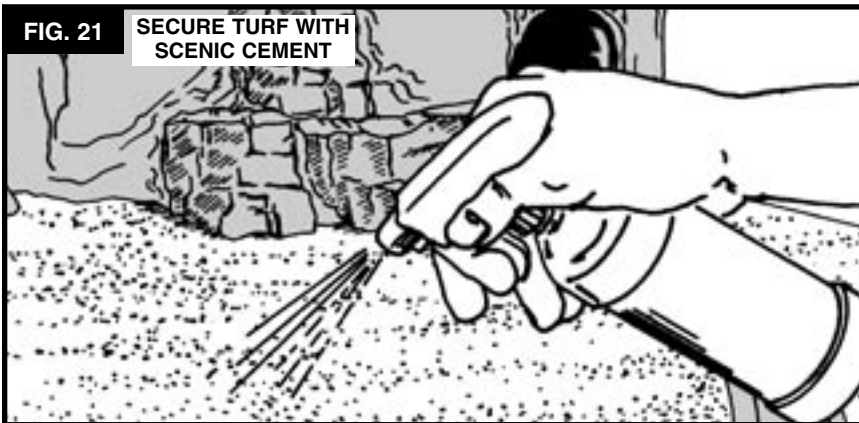
I. Now that you have completed coloring the base and sprinkling Turf, you may have some thicker areas or streaks of Turf. Lightly blow on those areas to distribute the Turf as evenly as possible. **NOTE:** Turf has not been secured at this time. If your layout will be left unattended for any length of time, continue through step 2 (Blend Turf Colors) before stopping.

## 2. BLEND THE COLORS:

A. Cut off one corner from each bag of the other Turf colors - Yellow Grass, Burnt Grass, Soil, and Earth. Apply the different colors of Turf in random, various sized patches so that Turf has a natural appearance. Begin with the mountainous areas.

Pour 1/2 bag of Yellow Grass into 4 oz. cup and lightly sprinkle in a salt and pepper fashion. Yellow Grass can indicate areas which may not get as much water, such as the sides of slopes. Repeat with Burnt Grass which provides a variation in the basic green coloring. Follow with Soil and Earth which can be used to make a trail, gully, or indicate more barren spots of ground. Use these

**FIG. 21** SECURE TURF WITH SCENIC CEMENT



**TECH TIP:** A dirt road or path can be created on your layout by applying Earth or Soil Turf with the "Dry Brushing" technique (see page 33). Several additional colors of Turf are available at your local hobby shop.

accent colors more sparingly than the basic Green Blend Blended Turf and blend them into each other so you do not have severe splotches of color. If you feel you have added too much of one color, just oversprinkle another color in a salt and pepper fashion.

B. Sprinkle some of the leftover Turf colors in a similar manner on the flat part of the layout, following the method previously described. Save remaining Turf colors for use in the section “FINISHING TOUCHES”.

C. When you are satisfied with the overall appearance, gently mist all Turf with Scenic Cement, beginning 18" to 24" away and gradually bringing the spray head closer to secure the Turf without blowing it away. Spray turf areas until thoroughly wet (Fig. 21). Allow to dry thoroughly and then blow off any excess Turf before continuing.

## VI. ADD MEDIUM GROUND COVER

Read through all instructions in this section before beginning.

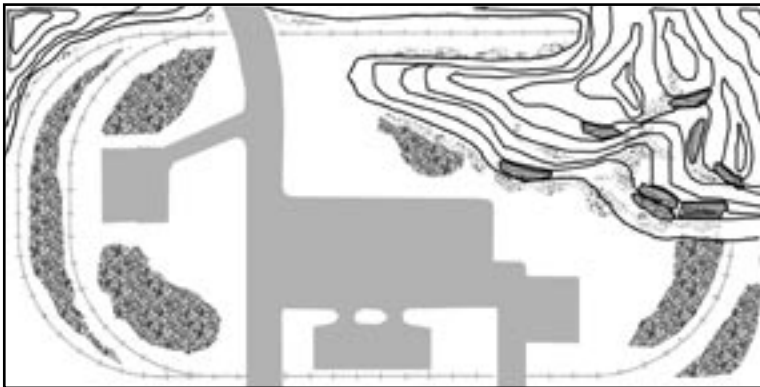
Medium ground cover includes the vines, medium level weeds, and miscellaneous plants. We have also included Talus (the rock debris found around rock outcroppings) in this section. Medium ground cover adds texture and realism to a model. When adding medium ground cover, most landscaping products will overlap. This adds a realistic touch to your layout.

### 1. ADD TALUS (ROCK DEBRIS):

Talus is the rock debris which collects beneath cliffs, around the base of mountains, in erosion ruts and in ravines. Refer to Fig. 22 for suggestions on placement of Talus. Turn bag of Talus upside down and shake to mix the various sizes. **NOTE:** If you want to color your Talus to match your rocks, refer to page 33 “1. MAKING IT MATCH - STAINING TALUS”.

FIG. 22

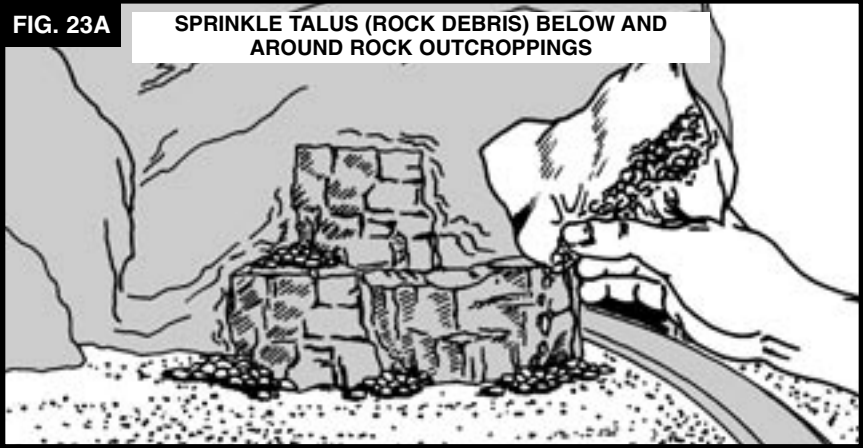
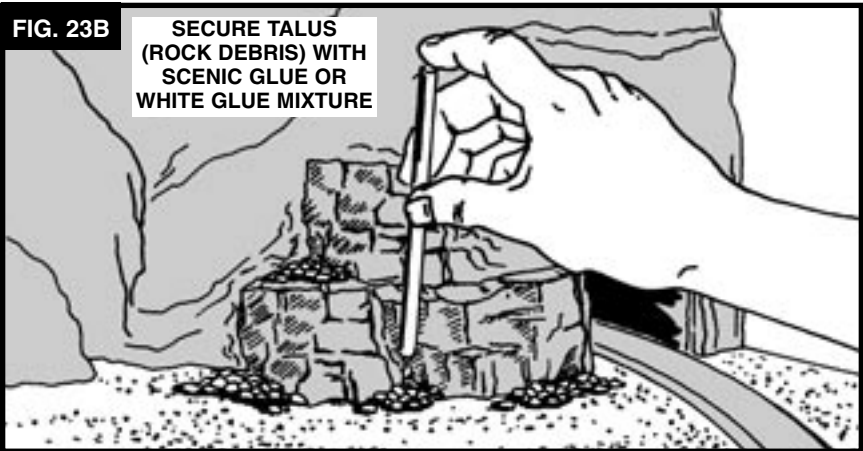
SUGGESTED PLACEMENT OF POLY FIBER AND TALUS (ROCK DEBRIS)



Legend

Poly-Fiber

Talus (Rock Debris)

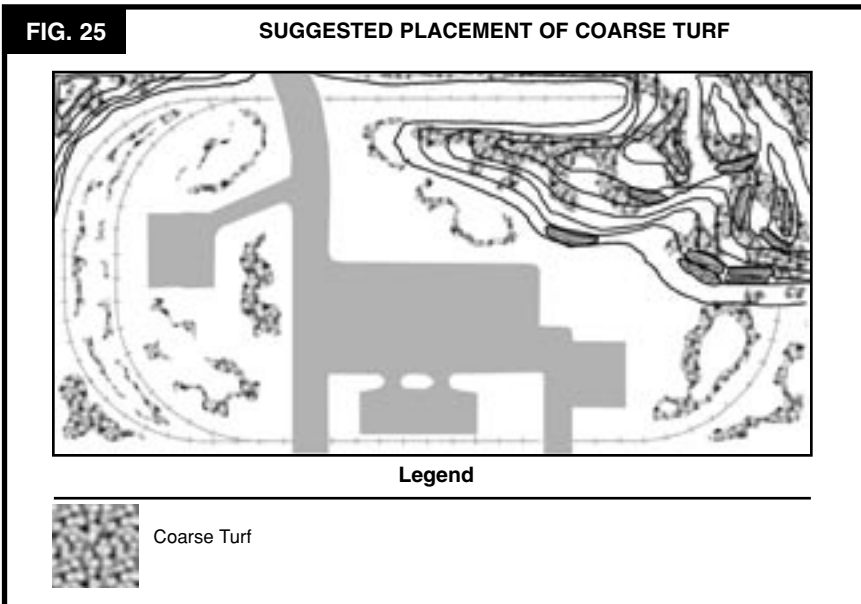
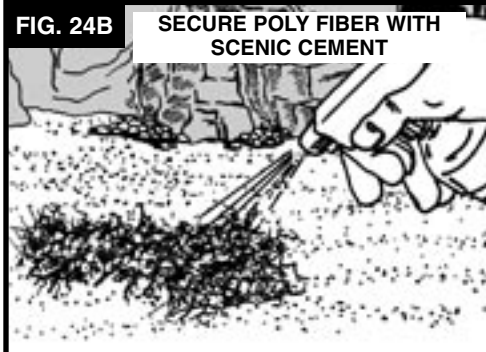
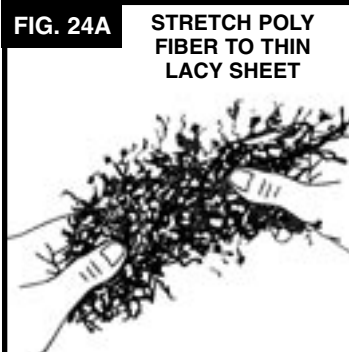
**FIG. 23A****SPRINKLE TALUS (ROCK DEBRIS) BELOW AND AROUND ROCK OUTCROPPINGS****FIG. 23B****SECURE TALUS (ROCK DEBRIS) WITH SCENIC GLUE OR WHITE GLUE MIXTURE**

A. Cut off one corner of the bag of Talus and use it as a shaker to sprinkle the Talus (Fig. 23A). Be sure to add Talus below and around the rock outcroppings and cliffs, in erosion ruts and ravines.

B. Mix equal parts of Scenic Glue or white glue and water and a drop or two of liquid detergent to make glue flow. With a straw or eyedropper, generously drop this mixture on the Talus to attach it (Fig. 23B). Allow to dry completely. When the glue is dry, apply another coat in the same manner and allow to dry.

## **2. SPREAD POLY FIBER AND APPLY COARSE TURF:**

A. Pull off a small amount of Poly Fiber, a green, synthetic material which looks like steel wool. **WARNING: Never use steel wool on your layout because the magnets in your engine will attract it, and it will damage your engine.** Stretch and pull this material to a thin, lacy sheet (Fig. 24A). See Fig. 22 for suggested placement. Attach Poly Fiber to the layout to indicate low ground cover plants (Fig. 24B). Poly Fiber can also be used to indicate vines on trees or buildings. **OPTIONAL:** Mist lightly with Scenic Cement to secure.

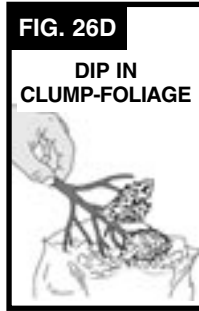


B. The Medium Green Coarse Turf provides texture variations and can indicate weeds, coarse grass, and small plants. See Fig. 25 for suggested placement. Using Scenic Cement, lightly spray area where you will place Coarse Turf. Sprinkle on the Coarse Turf and pat lightly to adhere. **NOTE:** These types of plants would not have an even coverage over all areas.

C. With Scenic Cement, lightly overspray all areas where the different types of ground cover have been added.

D. While Scenic Cement is still damp, carefully add a few small pinches of Coarse Turf, Burnt Grass Turf or Yellow Grass Turf to tops of Poly Fiber to add leaf structure and color variation.

E. Allow to dry completely.



## VII. ADD HIGH GROUND COVER

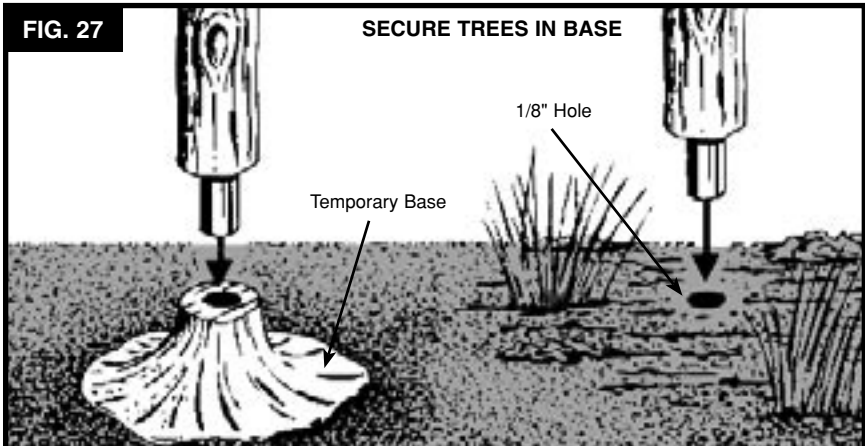
Read through all instructions in this section before beginning.

High ground cover includes bushes, shrubs, tall grass and trees. When you have completed this section, you will be ready to add some finishing touches to your layout.

### 1. ASSEMBLE AND INSTALL TREES:

A. Remove the temporary bases from the Tree Armatures. Twist and bend a Tree Armature to a three-dimensional shape (Fig. 26A-B). Brush Hob-e-Tac on the branches of the armature (Fig. 26C). Wait 15 minutes or until the Hob-e-Tac is clear and tacky.

B. Dip the Tree Armature in a bag of Dark Green Clump-Foliage (Fig. 26D) or attach Clump-Foliage by hand to the branches. “Prune” trees by removing excess foliage. Stand the tree in the temporary base (Fig. 27). Repeat A and B. Trees may be placed around layout to decide permanent placement.



**PRODUCT TIP:** Depending on the area you are modeling and as your layout grows, you probably will want to purchase additional trees for your layout. Trees tend to grow in family groups and look better when grouped on a layout. Woodland Scenics Realistic Tree Kits and Ready Made Trees are available in both deciduous and pine styles and in a wide range of colors and sizes.

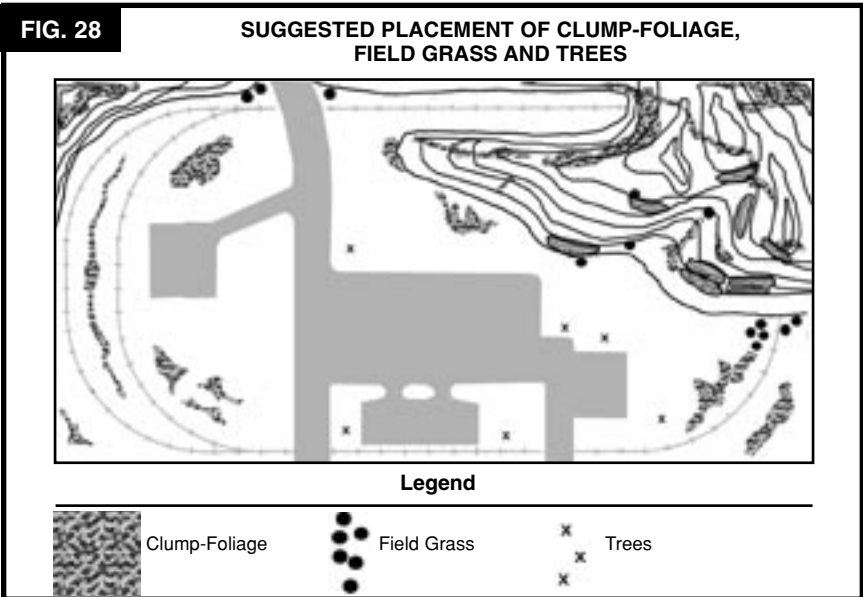
C. With the point of a hobby or utility knife, make a small hole in the Plaster Cloth where you want to plant a tree (Fig. 27). See Fig. 28 for suggestions for placement of trees. To plant trees on a plywood or other hardboard base, drill a 1/8" hole in the base. Remove a tree from the temporary base, apply a dab of Hob-e-Tac Adhesive or Scenic Glue to the end of tree pin and plant the tree in the hole (Fig. 27). Repeat with the other trees. If you buy more trees to add to your layout, keep in mind that trees usually grow close together in random sized family groups.

**2. CLUMP-FOLIAGE:**

A. Create bushes and shrubs with Clump-Foliage. See Fig. 28 for suggested areas. Place dots of Scenic Glue or white glue on the layout where you want bushes and press the Clump-Foliage pieces into them (Fig. 29A and 29B).

B. Use all three colors of Clump-Foliage. Bushes would generally grow in family groups of one color rather than as individual plants. Avoid a polka-dotted look.

C. Lightly spray the tops of a few of the Clump-Foliage bushes with Scenic Cement and sprinkle on some very small pinches of Turf for color highlights.



**FIG. 30A**

**ROLL FIELD  
GRASS TO  
UNEVEN  
LENGTH**

**FIG. 30B**

**CUT ONE END  
EVENLY**

**FIG. 30C**

**DIP INTO  
HOB-E-TAC**

**FIG. 30D**

**PLANT FIELD  
GRASS**



### **3. FIELD GRASS:**

A. Remove the Field Grass from the package. Separate a small clump from the batch. Roll a small clump between your thumb and index finger to produce uneven lengths (Fig. 30A). Cut the other end of the clump evenly with scissors to an appropriate length (Fig. 30B). Remember that 1" equals 87" in HO scale, so 3/8" to 3/4" is an appropriate length.

B. On a scrap piece of paper place a small amount of Hob-e-Tac Adhesive. Dip the blunt end of the Field Grass in the Hob-e-Tac Adhesive (Fig. 30C) and glue (Fig. 30D) where desired on the layout. See Fig. 28 for some suggested locations. Repeat procedure to plant additional clumps of Field Grass.



# FINISHING TOUCHES

A model or layout is never truly done because there are always additions or changes you will want to make. It's fun and challenging. Detailing and finishing touches are the extra steps which provide additional realism and interest to a model. Many of these detailing finishing touches use the same products which have been used earlier, perhaps with a slightly different technique. Allow the layout to dry completely from all previous steps before beginning the detailing.

## VIII. DETAILING

Read through all instructions in this section before beginning.

### 1. MAKING IT MATCH - STAINING TALUS (ROCK DEBRIS):

If your Talus (Rock Debris) does not closely resemble the color you have colored the rocks, you can achieve a more realistic look by staining the Talus with washes. Color Talus by using techniques you learned in "Color Rock Castings", page 22. Talus may require heavier concentration of pigments. Allow to dry completely.

### 2. ADD ADDITIONAL LANDSCAPE MATERIALS:

A. There may be several areas of your layout where you want additional landscaping materials to create more color variation, add more color, cover up splotches of glue or plaster, or disguise some other undesirable feature. Additional landscaping materials add texture and realism, and create more interest in the scenery.

B. More Turf, Coarse Turf, Clump-Foliage bushes, Poly Fiber ground cover, and Field Grass clumps can easily be added at this time. Refer back to the original directions for adding these items and add them in the same way now. To add more Blended turf, use the same techniques you learned in "Blend Turf Colors", page 26. If you need more of any of these items, listed on page 39, they can be purchased at your local hobby shop. Woodland Scenics landscaping products are versatile and their colors can be blended together. Experiment on your own using your own techniques.

### 3. DRY BRUSHING:

A. *Dry brushing* with Turf is an easy technique which allows you to see the results before permanently attaching the Turf. Dip a dry paintbrush with soft fibers into any of the colors of Turf and brush it on the layout where you want it. Add some Soil or Earth Turf on top of the Talus and along the edges of the Ballast and rock castings to represent dirt which would collect there. Soil or Earth Turf may also be dry brushed on your layout to indicate dirt roads. and paths.

B. Dry brush some Burnt Grass or Earth Turf around the bottom of the trees to cover any Hob-e-Tac Adhesive which appears there and to model the weeds and grasses which might grow there. Use some Burnt Grass Turf around the base of the Field Grass to cover Hob-e-Tac Adhesive.

C. When you like the look you have created, mist lightly with Scenic Cement to hold the Turf in place.

**PRODUCT TIP:** You may want to trim out your tunnel entrance with Woodland Scenics' ready-to-stain, highly detailed HO scale tunnel portals and retaining walls. They add the finishing touches to a layout. These portals meet NMRA standards and are available in four styles.

**FIG. 31** FLYSPECK TURF ONTO  
SIDE OF ROCKS



#### **4. FLYSPECKING WITH TURF:**

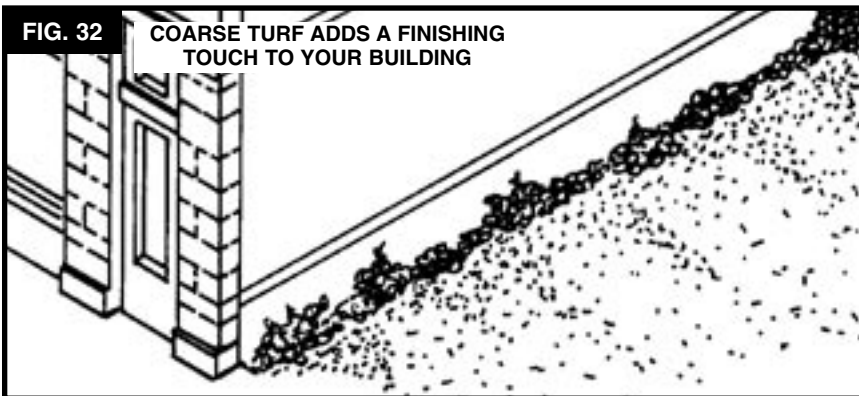
A. Dirt and soil collects in many areas, including on rock faces. Dirt and soil on rock faces may be indicated with a technique called flyspecking.

B. Mist the rock castings with Scenic Cement. Bend a sheet of paper into an “L” or “J” shape. Place a small amount of Soil Turf on the horizontal section of the paper. Hold the paper near the surface to be flyspecked and gently puff air on the vertical section of the paper (Fig. 31). This will blow specks of Soil onto the rock castings. If the area now has too much Soil, allow to dry and brush it off with a dry paintbrush. To attach permanently, mist with Scenic Cement from 18" to 24" away, gradually moving closer.

#### **5. BLEND YOUR STRUCTURES INTO SCENE:**

If you place buildings on your layout, you will want them to appear to be settled-in rather than stuck-on (Fig. 32). Follow the methods mentioned previously to add Coarse Turf, Clump-Foliage and Poly Fiber around the base of buildings to “ground” them to the layout.

**FIG. 32** COARSE TURF ADDS A FINISHING  
TOUCH TO YOUR BUILDING



## **IX. FIX UP AND CLEAN UP**

Read through all instructions in this section before beginning.

You're almost there! These last few steps are just good craftsmanship and will not take long. If you have any Scenic Cement left, overspray all landscaping. This will make everything on the layout more permanent.

### **1. PAINT THE EDGES:**

If desired, paint the outside of the mountain profiles and edge of the base by spraying or rolling on paint. You may use any color you desire. Before you paint, we recommend you fill and strengthen scored edges of the corrugated cardboard corners and gaps between mountain profiles and base using Woodland Scenics' Flex Paste. Spread Flex Paste with putty knife, let dry and sand. Then, apply a second coat of Flex Paste, let dry and sand. If you spray paint, mask layout with newspapers before spraying to keep the paint off the top surface. Follow instructions on the can. Apply a second coat of paint after the first has dried. If using latex paint, roll on an even coat. Apply a second coat after the first has thoroughly dried.

### **2. REMOVE MASKS:**

After the layout has completely dried, remove all masking materials. Touch up any areas as necessary.

### **3. CLEAN TRACK:**

Track must be free of all terrain and landscape materials, cement, etc. for trains to run smoothly. Clean top of rails with 600-grit wet/dry sandpaper or a track cleaner recommended by your local hobby shop. Hook up your power supply, place your engine and rolling stock on the track, and begin operations.

## A FINAL WORD

Now that you have added terrain and landscaping to your layout, you probably will want to add some other features. The enclosed Buyer's Guide includes all the Woodland Scenics' products that are available for use on your layout. Look for them at your local hobby shop.

Woodland Scenics products you may want to consider adding to your layout:

1. Add SubTerrain Risers, Inclines, Foam Sheets and Profile Boards.
2. Tunnel Portals and Retaining Walls in any of four styles will enhance the appearance of your layout.
3. Comprehensive lines of detailed Trackside Scenes, Mini-Scenes, Complete Scenes and Scenic Details are available. They will delight the eye with their authentic details and sometimes wry humor and are sure to catch the interest of every viewer.
4. A comprehensive line of Dry Transfer Decals will add the finishing touches to commercial buildings of almost any era.
5. For additional information on using the Terrain and Landscape products included in this kit, refer to the Woodland Scenics' *Scenery Manual*, *The Clinic* or *Model Scenery Made Easy* Videos which are all available at your local hobby shop.

**FINAL NOTE:** Buildings on our model and in our photographs are easy-to-assemble, highly detailed plastic kits from Design Preservation Models. Other details are from Woodland Scenics and various other manufacturers. See all the products at your local hobby shop.

# GLOSSARY

**Ballast:** gravel or broken stone graded for size, laid in a railroad bed to give strength and stability to ties and rail, and allow for easy drainage of water.

**Benchwork:** the structure underneath a model railroad that holds it up.

**Blending:** to combine at least two shades of something so that there is a color or size gradation but no exact border between the areas can be distinguished.

**Styrofoam:** a lightweight foam material commonly used for model contouring. Increasingly is being used as a base for model railroad modules.

**Clearance:** the distance by which one object clears another, or the clear space between them, such as the space allowed around buildings and scenery items so that they do not interfere with the running of trains.

**Dry brushing:** a technique of adding specks of color to rock castings. Spray water on the castings. Bend a sheet of paper into an L or J shape and place a small amount of Turf on the horizontal section of the sheet. Puff air lightly on the vertical section to blow a small amount of the Turf onto the castings. Set with Scenic Cement when you like the result.

**Frog:** part of the switch or turnout; a device permitting the wheels on the rail of a track to cross an intersection rail. See Fig. 3C, page 11.

**Gauge:** the distance between the rails of a railroad track. Compare to Scale.

**Gusset:** a triangular insert in a seam to provide reinforcement.

**Hardshell:** see Terrain shell.

**HO Scale:** Scale most commonly modeled. 1:87, one inch on model represents 87 inches in real world. Page 8.

**Landscape, landscaping:** the plant and tree cover on an area.

**Layout:** an entire model railroad, including track, terrain, landscaping, buildings, etc. A layout may be built in one or more sections called modules.

**Leopard spot:** to place spots of different colors in no particular pattern, as in the random spots on a leopard.

**Mask:** to cover for protection.

**Mix, mixed, mixing:** to combine or merge into one mass.

**Module:** a portable unit that is part of a total structure such as a model railroad. Often clubs or groups of people agree to build modules to the same particular specifications so that the modules may be joined together for some purpose such as running model trains.

**National Model Railroad Association (NMRA):** an organization of people interested in model railroading as a hobby. For membership information, contact NMRA, Inc., 4121 Cromwell Rd., Chattanooga, TN 37421.

**Operations:** the practical application of principles or processes. In model railroading, the movement for trains in a prototypical manner.

**Peek-a-boo:** an expression referring to the appearance and disappearance of model trains as they move through scenery and terrain areas.

**Piece of Rolling Stock:** one freight or passenger car used by a railroad, See rolling stock.

**Profile:** a shape or outline; often the edge of a model; a drawing showing the vertical section of the ground.

**Rail:** a bar of rolled steel forming a track for wheeled vehicles. Compare to Track.

**Roadbed:** the area directly beneath the ties and rail of a railroad track.

**Road System:** a system created by Woodland Scenics which allows you to add paved areas to any layout. Uses Paving Tape, Smooth-It and Top Coats.

**Rolling stock:** includes all of the freight and passenger cars used by a railroad, See piece of rolling rock.

**Salt and pepper:** a method of applying accent colors of Turf in a fine sprinkle. Begin with as little as possible and add as much as desired.

**Scale:** a proportion between two sets of dimensions, i.e., the proportion between the size of a model and the dimensions of a real train, building, person, or landscape feature. Compare to Gauge.

**Strata:** layers of sedentary rock; various layers may be of different compositions.

**SubTerrain System:** a revolutionary foam product from Woodland Scenics which allows modelers to add mountains, hills or low-lying areas on any layout.

**Switch:** a device usually made of two movable rails and the necessary connections designed to turn an engine and cars from one track to another. Also, a railroad siding. (Verb) moving cars to different positions within terminal areas. see Turnout. See Fig. 3C, page 11.

**Talus (Rock Debris):** rock debris found at the base of a mountain or cliff, or washed down the streams and rivers that form the drainage system for the area. Consists of random sizes which are not graded.

**Terrain:** the physical features of a tract of land.

**Terrain shell:** the firm coating, usually made of some type of plaster, placed on top of the terrain base of a model railroad or other model for the purpose of providing a smooth surface on which to paint, place buildings, and add landscape materials. Also known as Hardshell.

**Texture:** the visual surface characteristics or closely interwoven elements of something. Also the various sizes of items in an area such as landscape items on a layout.

**Throws:** levers that move switch points made of treated wood, to which railroad rails are fastened to keep them in line.

**Track:** the parallel rails of a railroad which are gauged and control the movement of traffic. Compare to Rail.

**Track-Bed:** a roadbed product from Woodland Scenics which provides a quiet, smooth train operation, and is compatible with cork.

**Tree Armatures:** the framework or tree form to which materials to simulate foliage are added.

**Turnout:** a place where the track branches off. Sometimes a name for the entire device which allows a train to go from one track to another. See Switch. See also Fig. 3C, page 11.

**View block:** an item of scenery or structure that serves to prevent the viewer from seeing something behind it.

**Wet water:** a solution made from one or two drops of liquid soap mixed with 6-oz. water.

## PRODUCT NUMBER AND DESCRIPTION

We hope you have enjoyed using the Woodland Scenics materials included in this kit. The following list gives you the Woodland Scenics product number for the terrain and landscape products in the kit.

<u>NAME</u>	<u>DESCRIPTION</u>	<u>PRODUCT #</u>
Ballast	Buff, Fine	B73
Clump-Foliage	Light Green	FC182
Clump-Foliage	Medium Green	FC183
Clump-Foliage	Dark Green	FC184
Field Grass	Harvest Gold	FG172
Hob-e-Tac	Adhesive	S195
Lightweight Hydrocal*	Plaster material	C1201
Liquid Pigment	Black	C1220
Liquid Pigment	Burnt Umber	C1222
Liquid Pigment	Yellow Ocher	C1223
Liquid Pigment	Earth Undercoat	C1229
Plaster Cloth	Plaster impregnated cloth	C1203
Poly Fiber	Green	FP178
Rock Mold	Random Rock	C1234
Scenic Cement	Cement for scenery	S191
Talus (Rock Debris)	Buff, Fine	C1270
Talus (Rock Debris)	Buff, Medium	C1271
Trees	Realistic Tree Kit	TR1102
Fine Turf	Burnt Grass	T44
Fine Turf	Yellow Grass	T43
Fine Turf	Earth	T42
Fine Turf	Soil	T41
Coarse Turf	Medium Green	T64
Blended Turf	Green Blend	T49

# TRACK REQUIREMENTS

The following is a list of all the track sizes you will need to complete our layout. We recommend sectional track for this layout. **NOTE:** Any or all of the miscellaneous items may be optional, depending on the type of track.

The track plan shows the proper placement for each section of track. If you are installing a section of track and find that it does not fit, you may be using the wrong section.

ITEM	NUMBER OF PIECES
<b>SECTIONAL TRACK</b>	
6" Straight Track .....	3
9" Straight Track .....	10
18" Radius Track .....	16
#4 Left hand Switch .....	1 (with 1/3 18" radius)
#4 Right hand Switch .....	1 (with 1/3 18" radius)
1/3 18" Radius .....	2
<b>MISCELLANEOUS</b>	
Rail Joiners .....	75
Spikes .....	150
Roadbed .....	27

